

Part number

PEW 12564 PP



Wall-mounting socket outlet, PLUSO series, 3 poles + PE, 6 h (red), 125 A, 380 ÷ 415 V

Product description

Product type	Socket Wall-mounting
Series	PEW...PP, PLUSO
N. of poles	3 poles + 
Clock position	6

Technical data

Current	125 A
Voltage	380 ÷ 415 V
IP degree of protection	IP67

Further technical details

Weight	3.906,00 g
Operating temperature range (min, max)	-25°C ... +40°C

Material properties

Colour	RAL 7035 grey, RAL 3000 red
RoHs conformity	Compliant with exemption 6(c): copper alloy containing up to 4% lead by weight
China RoHs - EFUP	50
REACH SVHC substances	Yes Lead
SCIP number	Ca7de37f-add8-4b77-9861-279c94903ade

Approvals / Standards

Reference standard	EN 60309-1 and -2
---------------------------	-------------------

General ordering information

EAN13 code	8015747070379
-------------------	---------------

Packaging Information

Packaging length	170,00 mm
Packaging height	190,00 mm
Packaging width	400,00 mm
Packaging weight	4,20 kg
Packaging volume	12,92 dm ³
Packaging description	Carton box
Packaging quantity	1 Pcs
Packaging EAN code	8015747070386

Part number

PEW 12564 PP



Catalogue drawings

(63A) PEW ... PP

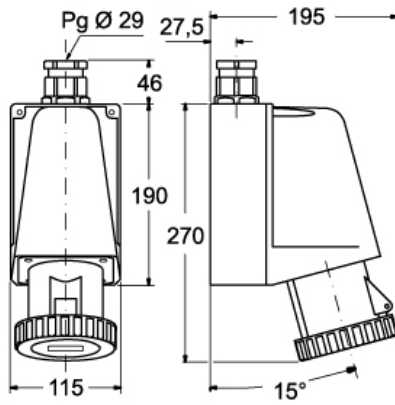

(125A) PEW ... PP

