

Part number

PE 3254 SI



Flush-mounting plug, PLUSO series, 3 poles + PE, 5 h (black), 32 A, 600 ÷ 690 V

Product description

Product type	Plug Flush-mounting
Series	PE...SI, PLUSO
N. of poles	3 poles + 
Clock position	5

Technical data

Current	32 A
Voltage	600 ÷ 690 V
IP degree of protection	IP44

Further technical details

Operating temperature range (min, max)	-25°C ... +40°C
---	-----------------

Material properties

Colour	RAL 7035 grey, RAL 9005 black
---------------	-------------------------------

Approvals / Standards

Reference standard	EN 60309-1 and -2
---------------------------	-------------------

General ordering information

EAN13 code	8015747155625
-------------------	---------------

Part number

PE 3254 SI



Catalogue drawings

(16 / 32A) PE ... SI

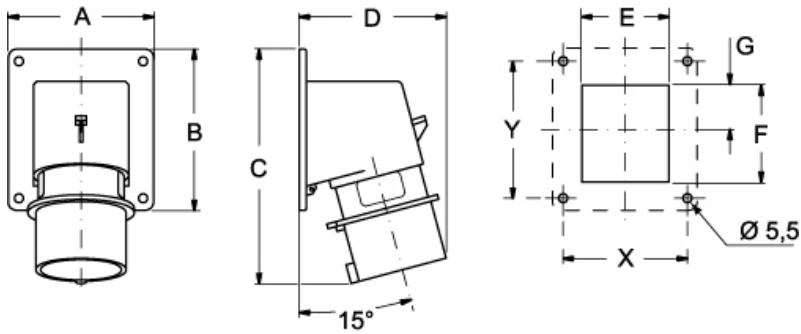

PE ... SI	A	B	C	D	E	F	G	X	Y
16A 2P+⊕	65	82	126	81	41	43	21,5	52	60
	65	82	126	81	47	43	21,5	52	60
	90	100	146	93	54	60	27,5	77	85
32A 2P+⊕	90	100	160	101	55	60	27,5	77	85
	90	100	160	101	55	60	27,5	77	85
	90	100	160	106	62	60	27,5	77	85