

Part number

MVAP 16LSP32



Surface mounting housing, V-TYPE series, with 1 lever, M32 cable entry, size "77.27", high construction, with SIMPLEX self-closing cover

Product description

Product type	Surface mounting housing
Series	V-TYPE
Closing type	With 1 lever
Size	Size 77.27
Cable entry	With cable entry M32
Specification	High construction, with SIMPLEX self-closing cover

Technical data

IP degree of protection	IP65
Further technical details	
Weight	449,00 g
Operating temperature range (min, max)	-40°C...+125°C

Material properties

Other materials	Lever: Stainless steel Gasket: NBR
Colour	RAL 7040 grey
RoHs conformity	Compliant
China RoHs - EFUP	E
REACH SVHC substances	No

Approvals / Standards

Certifications	DNV, BV
UL	ECBT2
cUL	ECBT8

General ordering information

EAN13 code	8015747229449
eCl@ss 8.1	27440202
ETIM 7.0	EC000437

Packaging Information

Packaging weight	4,50 kg
Packaging volume	18,29 dm ³
Packaging description	Carton box
Packaging quantity	10 Pcs
Packaging EAN code	8015747229586
Sub-packaging weight	2,25 kg
Sub-packaging description	Plastic packaging
Sub-packaging quantity	5 Pcs
Sub-packaging EAN barcode	8015747229593

Part number

MVAP 16LSP32



Catalogue drawings

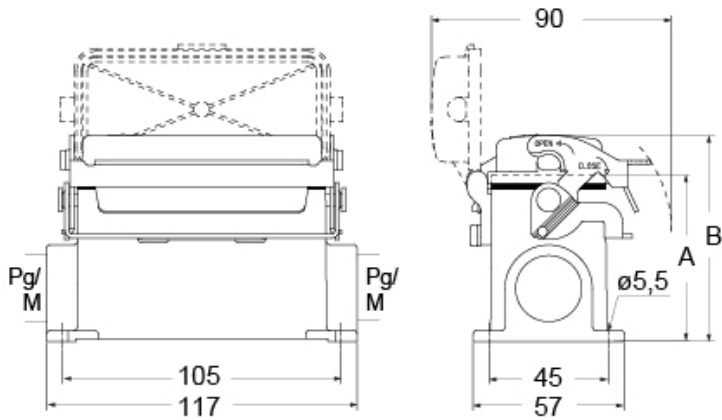

part No.	A	B
CVP / MVP 16 LSP	63	78
CVAP / MVAP 16 LSP	81	96