

Part number

MMAP 16CS232



Surface mounting housing, 830V series, with 4 pegs, M32 x 2 cable entry, size "104.27", high construction, with metal cover

Product description	
Product type	Surface mounting housing
Series	830V
Closing type	With 4 pegs
Size	Size 104.27
Cable entry	With cable entry M32 x 2
Specification	High construction, with metal cover
Technical data	
IP degree of protection	IP65
Further technical details	
Weight	505,00 g
Operating temperature range (min, max)	-40°C...+125°C

Material properties	
Colour	RAL 7040 grey
RoHs conformity	Compliant
China RoHs - EFUP	E
REACH SVHC substances	No
Approvals / Standards	
Certifications	DNV, BV
UL	ECBT2
cUL	ECBT8
General ordering information	
EAN13 code	8015747057851
Packaging Information	
Sub-packaging weight	2,53 kg
Sub-packaging description	Plastic packaging
Sub-packaging quantity	5 Pcs
Sub-packaging EAN barcode	8015747106641

Part number

MMAP 16CS232



Catalogue drawings

CMP CMAP - MMP MMAP

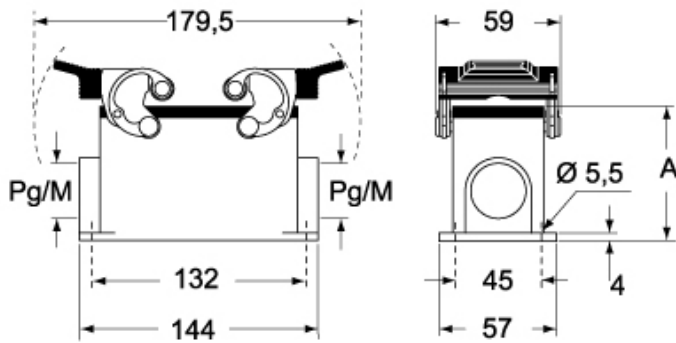

CMP CS/CP CMAP CS/CP - MMP CS/CP MMAP CS/CP



	A
CMP / MMP	63
CMAP / MMAP	80
CMP CS / MMP CS	63
CMAP CS / MMAP CS	80
CMP CP / MMP CP	63
CMAP CP / MMAP CP	80