

Part number

# MMAP 06 L40



Surface mounting housing, 830V series, with 1 lever, M40 cable entry, size "77.27", high construction

Product description		Material properties	
<b>Product type</b>	Surface mounting housing	<b>Colour</b>	RAL 7040 grey
<b>Series</b>	830V	<b>RoHs conformity</b>	Compliant
<b>Closing type</b>	With 1 lever	<b>China RoHs - EFUP</b>	E
<b>Size</b>	Size 77.27	<b>REACH SVHC substances</b>	No
<b>Cable entry</b>	With cable entry M40	<b>Approvals / Standards</b>	
<b>Specification</b>	High construction	<b>Certifications</b>	DNV, BV
<b>Technical data</b>		<b>UL</b>	ECBT2
<b>IP degree of protection</b>	IP65 / IP66 / IP69	<b>cUL</b>	ECBT8
<b>Further technical details</b>		<b>General ordering information</b>	
<b>Weight</b>	369,00 g	<b>EAN13 code</b>	8015747057523
<b>Operating temperature range (min, max)</b>	-40°C...+125°C	<b>Packaging Information</b>	
		<b>Sub-packaging weight</b>	1,85 kg
		<b>Sub-packaging description</b>	Plastic packaging
		<b>Sub-packaging quantity</b>	5 Pcs
		<b>Sub-packaging EAN barcode</b>	8015747106412

Part number

# MMAP 06 L40



Catalogue drawings

## CMP L CMAP L - MMP L MMAP L



## CMP LS CMAP LS - MMP LS MMAP LS

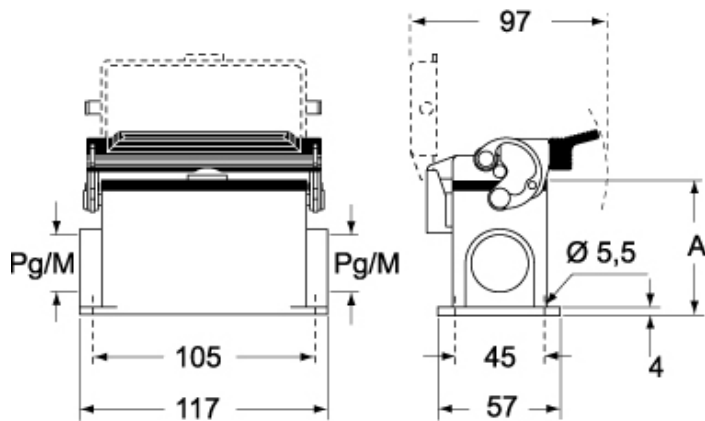

	<b>A</b>
<b>CMP L / MMP L</b>	63
<b>CMAP L / MMAP L</b>	77
<b>CMP LS / MMP LS</b>	63
<b>CMAP LS / MMAP LS</b>	77