

Part number

MHV 32.50



Hood, C-TYPE series, with 4 pegs, M50 top cable entry, size "77.62"

Product description

Product type	Hood
Series	C-TYPE
Closing type	With 4 pegs
Size	Size 77.62
Cable entry	Top cable entry with adapter M50

Technical data

IP degree of protection	IP65 / IP66 / IP69
--------------------------------	--------------------

Further technical details

Weight	494,00 g
Operating temperature range (min, max)	-40°C...+125°C

Material properties

Colour	RAL 7040 grey
RoHs conformity	Compliant with exemption 6(c): copper alloy containing up to 4% lead by weight
China RoHs - EFUP	50
REACH SVHC substances	Yes Lead
SCIP number	15deaf78-e939-4401-a0b0-e2228ca32a03

Approvals / Standards

Certifications	DNV, BV
UL	ECBT2
cUL	ECBT8

General ordering information

EAN13 code	8015747056373
eCl@ss 8.1	27440202
ETIM 7.0	EC000437

Packaging Information

Packaging length	370,00 mm
Packaging height	140,00 mm
Packaging width	210,00 mm
Packaging weight	4,23 kg
Packaging volume	10,88 dm ³
Packaging description	Carton box
Packaging quantity	8 Pcs
Packaging EAN code	8015747110594
Sub-packaging weight	0,53 kg
Sub-packaging description	Plastic packaging
Sub-packaging quantity	1 Pcs
Sub-packaging EAN barcode	8015747110600

Part number

MHV 32.50



Catalogue drawings

**CHO - CHV MHO/MFO/MFV - MHV
MMV (MMAV)**

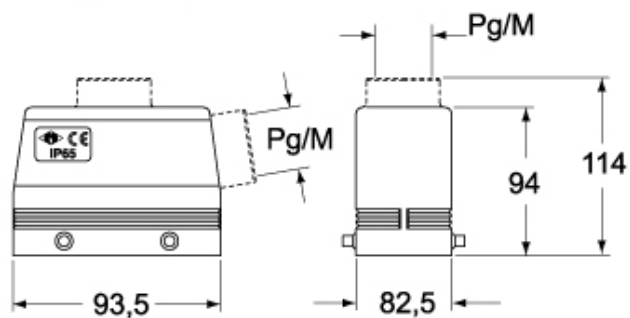

CHV G - MHV G - MFV G

