

Part number

MAV 16.225



Hood, C-TYPE series, with 4 pegs, M25 x 2 double top cable entry, size "77.27", high construction

Product description

Product type	Hood
Series	C-TYPE
Closing type	With 4 pegs
Size	Size 77.27
Cable entry	Double top cable entry with adapter M25 x 2
Specification	High construction

Technical data

IP degree of protection IP65 / IP66 / IP69

Further technical details

Weight	286,00 g
Operating temperature range (min, max)	-40°C...+125°C

Material properties

Colour	RAL 7040 grey
RoHs conformity	Compliant with exemption 6(c): copper alloy containing up to 4% lead by weight
China RoHs - EFUP	50
REACH SVHC substances	Yes Lead
SCIP number	15deaf78-e939-4401-a0b0-e2228ca32a03

Approvals / Standards

Certifications	DNV, BV
UL	ECBT2
cUL	ECBT8

General ordering information

EAN13 code	8015747052603
eCl@ss 8.1	27440202
ETIM 7.0	EC000437

Packaging Information

Packaging length	190,00 mm
Packaging height	140,00 mm
Packaging width	290,00 mm
Packaging weight	2,87 kg
Packaging volume	7,71 dm ³
Packaging description	Carton box
Packaging quantity	10 Pcs
Packaging EAN code	8015747262118
Sub-packaging weight	1,44 kg
Sub-packaging description	Plastic packaging
Sub-packaging quantity	5 Pcs
Sub-packaging EAN barcode	8015747052610

Part number

MAV 16.225



Catalogue drawings

CZAV L2 - (MZAV L2) - [MZFV L2]

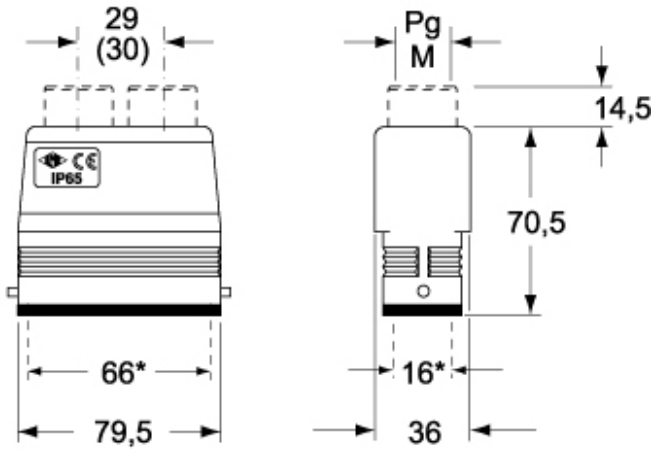

CAV - MAV - MFV

