

Part number

MAP 24 LS40



Surface mounting housing, C-TYPE series, with 1 lever, M40 cable entry, size "104.27", high construction, with metal cover

Product description	
Product type	Surface mounting housing
Series	C-TYPE
Closing type	With 1 lever
Size	Size 104.27
Cable entry	With cable entry M40
Specification	High construction, with metal cover
Technical data	
IP degree of protection	IP65
Further technical details	
Weight	530,00 g
Operating temperature range (min, max)	-40°C...+125°C

Material properties	
Other materials	Lever: Stainless steel, polyamide (PA) Gasket: NBR
Colour	RAL 7040 grey
RoHs conformity	Compliant
China RoHs - EFUP	E
REACH SVHC substances	No
Approvals / Standards	
Certifications	DNV, BV
UL	ECBT2
cUL	ECBT8
General ordering information	
EAN13 code	8015747051958
eCl@ss 8.1	27440202
ETIM 7.0	EC000437
Packaging Information	
Packaging length	475,00 mm
Packaging height	220,00 mm
Packaging width	200,00 mm
Packaging weight	5,40 kg
Packaging volume	20,90 dm ³
Packaging description	Carton box
Packaging quantity	10 Pcs
Packaging EAN code	8015747250122
Sub-packaging weight	2,70 kg
Sub-packaging description	Plastic packaging
Sub-packaging quantity	5 Pcs
Sub-packaging EAN barcode	8015747051965

Part number

MAP 24 LS40



Catalogue drawings

CHP L CAP L - MHP L MAP L

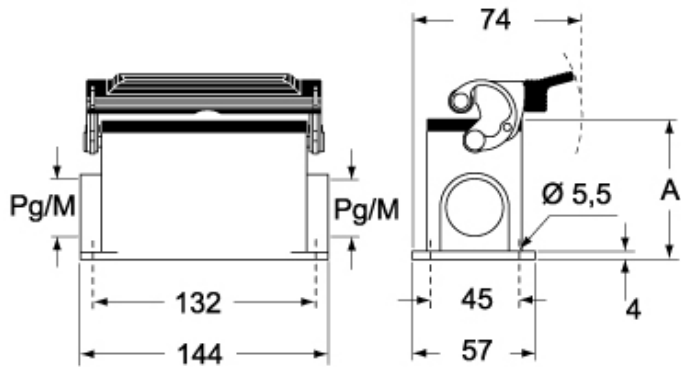

CHP LS CAP LS - MHP LS MAP LS

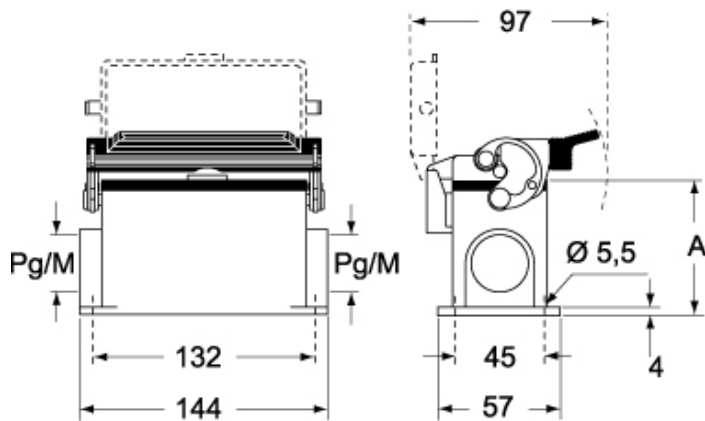

	A
CHP L / MHP L	63
CAP L / MAP L	80
CHP LS / MHP LS	63
CAP LS / MAP LS	80