

Part number
JCVP 16



Surface mounting housing, JEI®-V series, with 2 levers, Pg21 cable entry, size "77.27"

Product description

Product type	Surface mounting housing
Series	JEI®-V
Closing type	With 2 levers
Size	Size 77.27
Cable entry	With cable entry Pg21

Technical data

IP degree of protection	IP65 / IP66 / IP69
--------------------------------	--------------------

Further technical details

Weight	325,00 g
Operating temperature range (min, max)	-40°C...+125°C

Material properties

Other materials	Lever: Galvanized steel Gasket: NBR
Colour	RAL 7040 grey

Approvals / Standards

Certifications	DNV, BV
UL	ECBT2
cUL	ECBT8

General ordering information

EAN13 code	8015747137638
-------------------	---------------

Packaging Information

Packaging length	295,00 mm
Packaging height	160,00 mm
Packaging width	300,00 mm
Packaging weight	6,60 kg
Packaging volume	14,16 dm ³
Packaging description	Carton box
Packaging quantity	20 Pcs
Packaging EAN code	8015747144056
Sub-packaging weight	1,65 kg
Sub-packaging description	Plastic packaging
Sub-packaging quantity	5 Pcs
Sub-packaging EAN barcode	8015747140317

Part number
JCVP 16



Catalogue drawings

JCVP

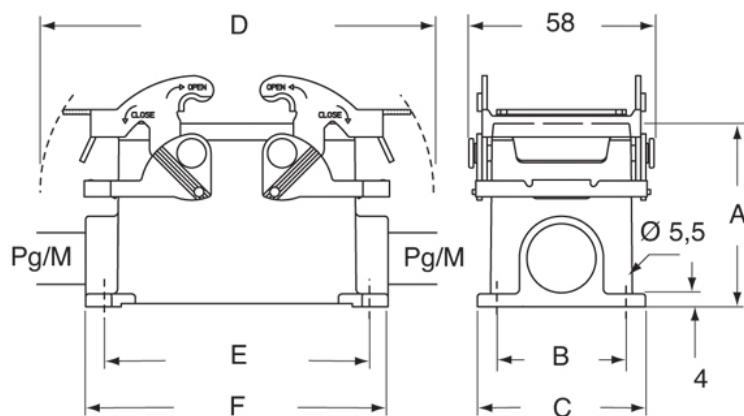

	A	B	C	D	E	F
JCVP 10	57	40	52	122	82	93,5
JCVP 16	63	45	57	142,5	105	117
JCVP 24	63	45	57	169	132	144