

Part number

FC 1141 TB



Modular back plate for socket outlets set mounting, FC series

Product description	
Product type	Modular back plate for socket outlets set mounting
Series	FC
Size	114x228 fixing plates FC xx41 TB
Further technical details	
Weight	295,00 g
Operating temperature range (min, max)	-40°C ... +125°C

Material properties	
Colour	RAL 7035 grey
General ordering information	
EAN13 code	8015747045216
Packaging Information	
Packaging length	225,00 mm
Packaging height	180,00 mm
Packaging width	435,00 mm
Packaging weight	3,90 kg
Packaging volume	17,62 dm ³
Packaging description	Carton box
Packaging quantity	10 Pcs
Packaging EAN code	8015747045223

Part number

FC 1141 TB



Catalogue drawings

FC 1141 TB

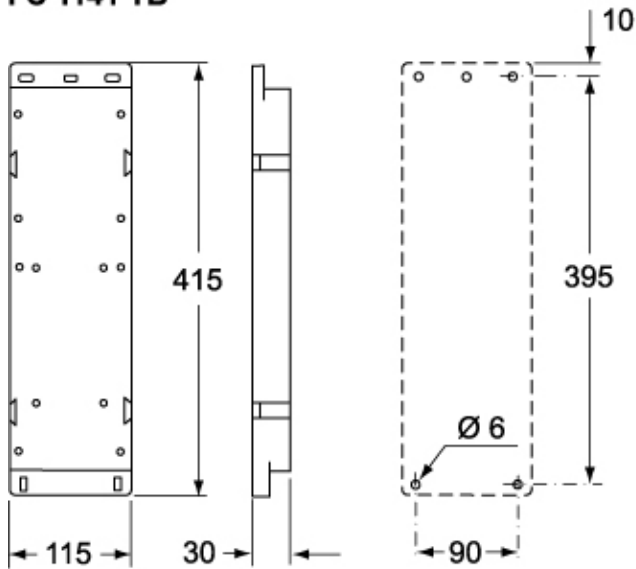

FC 1453 TB

