

Part number

CRZ 16



Reduction plate, size "104.27", with gasket, for bulkhead mounting housings size "77.27"

Product description		General ordering information	
Product type	Reduction plate	EAN13 code	8015747039727
Size	Size 104.27	eCl@ss 8.1	27440201
Specification	With gasket For bulkhead mounting housings size "77.27"	ETIM 7.0	EC002309
Further technical details		Packaging Information	
Weight	35,00 g	Packaging length	160,00 mm
		Packaging height	128,00 mm
		Packaging width	350,00 mm
		Packaging weight	1,95 kg
		Packaging volume	7,17 dm ³
		Packaging description	Carton box
		Packaging quantity	50 Pcs
		Packaging EAN code	8015747039734
		Sub-packaging weight	0,20 kg
		Sub-packaging description	Plastic packaging
		Sub-packaging quantity	5 Pcs
		Sub-packaging EAN barcode	8015747039741

Part number

CRZ 16



Catalogue drawings

CRH

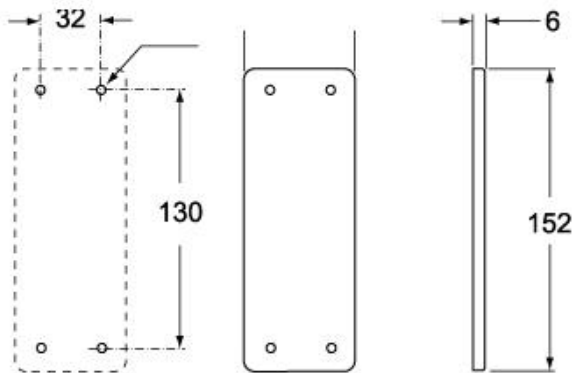

CRZ

