

Part number

CR 10 SC



Cable anchorage, for multiple shielded PE cables, for inserts size "57.27"

Product description

Product type	Cable anchorage
Size	Size 57.27
Specification	For standard inserts, for multiple shielded PE cables In zinc plated iron

Further technical details

Weight	15,00 g
---------------	---------

General ordering information

EAN13 code	8015747149136
eCl@ss 8.1	27449290
ETIM 7.0	EC002943

Packaging Information

Sub-packaging weight	0,02 kg
Sub-packaging description	Plastic bag
Sub-packaging quantity	1 Pcs
Sub-packaging EAN barcode	8015747166980

Part number

CR 10 SC



Catalogue drawings

CR...SC

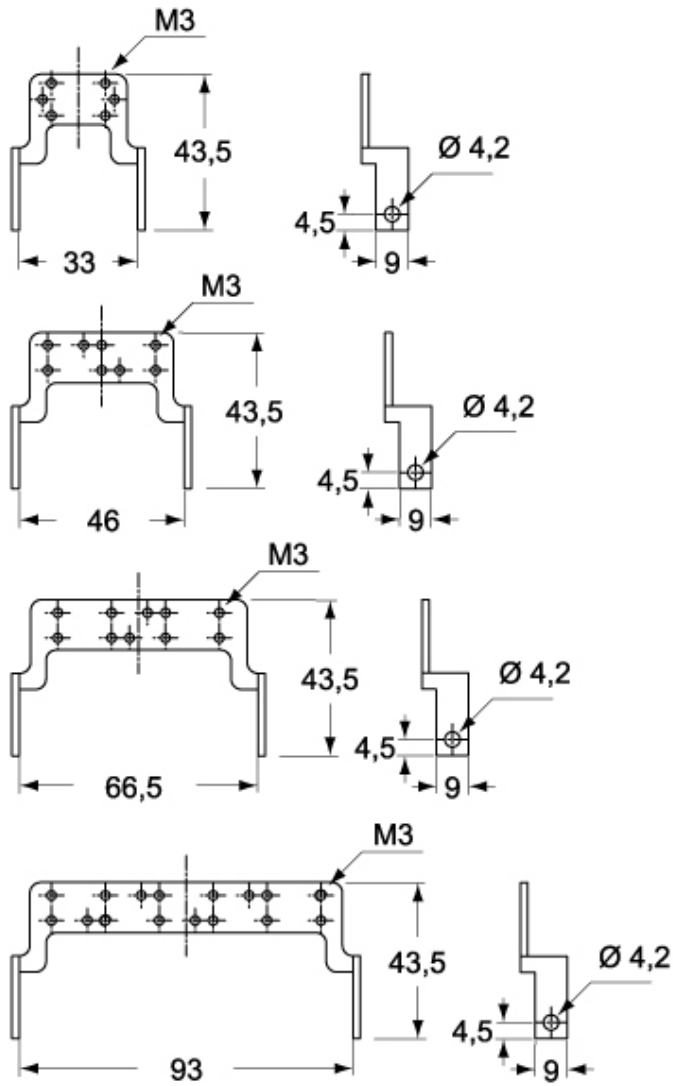

CR...CA

