

Part number

COB 06 BC



Connector carrier baseplate for mounting on DIN EN60715 rail or with screws, COB panel supports series, for inserts with 44 x 27 mm screw fixing centre distance

Product description	
Product type	Connector carrier baseplate for mounting on DIN EN60715 rail or with screws
Series	COB panel supports
Specification	For inserts with 44 x 27 mm screw fixing centre distance
Technical data	
IP degree of protection	IP20
Further technical details	
Weight	85,00 g
Operating temperature range (min, max)	-40°C...+125°C

Material properties	
Colour	RAL 7032 grey
RoHs conformity	Compliant with exemption 6(c): copper alloy containing up to 4% lead by weight
China RoHs - EFUP	50
REACH SVHC substances	Yes Lead
SCIP number	B008b8e4-629e-4e70-ab7d-b3b67464925d
Approvals / Standards	
Certifications	DNV, BV
UL	ECBT2
cUL	ECBT8
General ordering information	
EAN13 code	8015747036467
eCl@ss 8.1	27440206
ETIM 7.0	EC002312
Packaging Information	
Packaging length	275,00 mm
Packaging height	110,00 mm
Packaging width	430,00 mm
Packaging weight	2,15 kg
Packaging volume	13,01 dm ³
Packaging description	Carton box
Packaging quantity	20 Pcs
Packaging EAN code	8015747036474
Sub-packaging length	95,00 mm
Sub-packaging height	40,00 mm
Sub-packaging width	253,00 mm
Sub-packaging weight	0,54 kg
Sub-packaging volume	0,96 dm ³
Sub-packaging description	Carton tray
Sub-packaging quantity	5 Pcs
Sub-packaging EAN barcode	8015747036481

Part number

COB 06 BC



Catalogue drawings

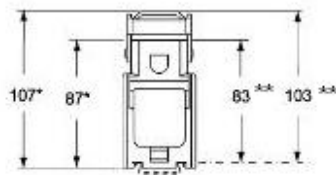
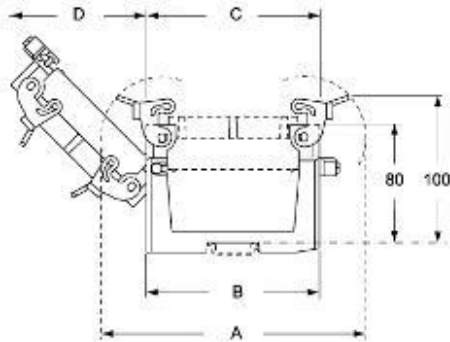

Catalogue drawings

COB..BC

