

Part number

CMI 06 CP



Bulkhead mounting housing, 830V series, with 4 pegs, size "77.27", with plastic cover

Product description

Product type	Bulkhead mounting housing
Series	830V
Closing type	With 4 pegs
Size	Size 77.27
Cable entry	Without cable entry
Specification	With plastic cover

Technical data

IP degree of protection	IP65
--------------------------------	------

Further technical details

Weight	118,00 g
Operating temperature range (min, max)	-40°C...+125°C

Material properties

Colour	RAL 7040 grey
RoHs conformity	Compliant
China RoHs - EFUP	E
REACH SVHC substances	No

Approvals / Standards

Certifications	DNV, BV
UL	ECBT2
cUL	ECBT8

General ordering information

EAN13 code	8015747030632
-------------------	---------------

Packaging Information

Sub-packaging weight	0,59 kg
Sub-packaging description	Plastic packaging
Sub-packaging quantity	5 Pcs
Sub-packaging EAN barcode	8015747104951

Part number

CMI 06 CP



Catalogue drawings

CMI

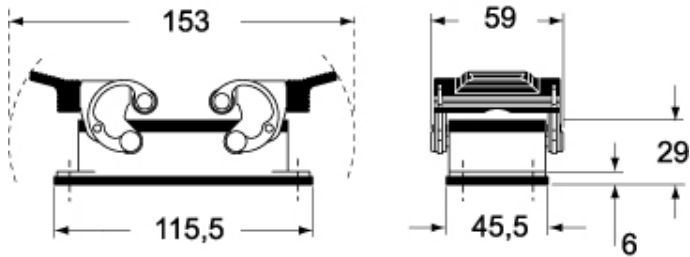

CMI CS/CP

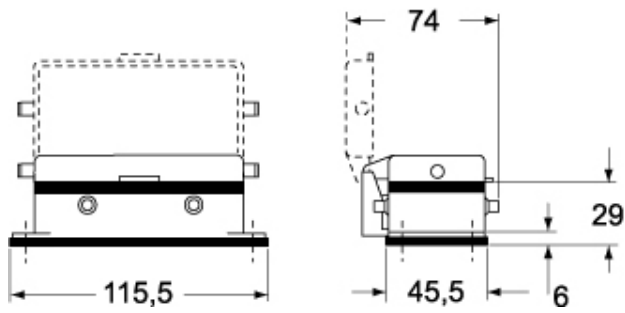

Catalogue drawings

