

Part number

# CMAV 03 L29



Hood, 830V series, with 2 pegs, Pg29 top cable entry, size "57.27", high construction

#### Product description

<b>Product type</b>	Hood
<b>Series</b>	830V
<b>Closing type</b>	With 2 pegs
<b>Size</b>	Size 57.27
<b>Cable entry</b>	Top cable entry Pg29
<b>Specification</b>	High construction

#### Technical data

**IP degree of protection** IP65 / IP66 / IP69

#### Further technical details

<b>Weight</b>	151,00 g
<b>Operating temperature range (min, max)</b>	-40°C...+125°C

#### Material properties

<b>Colour</b>	RAL 7040 grey
<b>RoHs conformity</b>	Compliant
<b>China RoHs - EFUP</b>	E
<b>REACH SVHC substances</b>	No

#### Approvals / Standards

<b>Certifications</b>	DNV, BV
<b>UL</b>	ECBT2
<b>cUL</b>	ECBT8

#### General ordering information

**EAN13 code** 8015747029698

#### Packaging Information

<b>Sub-packaging weight</b>	0,76 kg
<b>Sub-packaging description</b>	Plastic packaging
<b>Sub-packaging quantity</b>	5 Pcs
<b>Sub-packaging EAN barcode</b>	8015747104791

Part number

# CMAV 03 L29



Catalogue drawings

**CMO L (CMAO L) - MMO L [MMAO L]  
CMV L [CMAV L] - MMV L (MMAV L)**

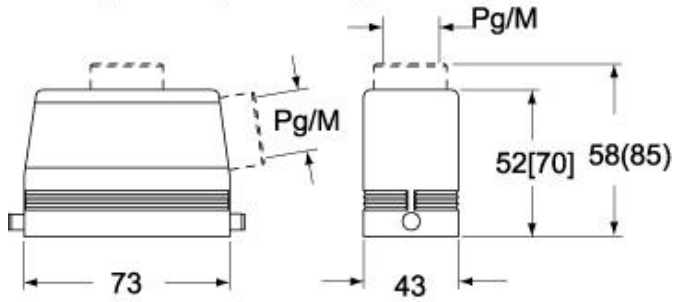

**CMV LG (CMAV LG) - MMV LG (MMAV LG)  
[MMFV LG]**

