

Part number

# CMAP 16 LS29



Surface mounting housing, 830V series, with 1 lever, Pg29 cable entry, size "104.27", high construction, with metal cover

## Product description

|                      |                                     |
|----------------------|-------------------------------------|
| <b>Product type</b>  | Surface mounting housing            |
| <b>Series</b>        | 830V                                |
| <b>Closing type</b>  | With 1 lever                        |
| <b>Size</b>          | Size 104.27                         |
| <b>Cable entry</b>   | With cable entry<br>Pg29            |
| <b>Specification</b> | High construction, with metal cover |

## Technical data

**IP degree of protection** IP65

## Further technical details

|   |                |
|---|----------------|
| <b>Weight</b>                                 | 510,00 g       |
| <b>Operating temperature range (min, max)</b> | -40°C...+125°C |

## Material properties

|                              |               |
|------------------------------|---------------|
| <b>Colour</b>                | RAL 7040 grey |
| <b>RoHs conformity</b>       | Compliant     |
| <b>China RoHs - EFUP</b>     | E             |
| <b>REACH SVHC substances</b> | No            |

## Approvals / Standards

|                       |         |
|-----------------------|---------|
| <b>Certifications</b> | DNV, BV |
| <b>UL</b>             | ECBT2   |
| <b>cUL</b>            | ECBT8   |

## General ordering information

**EAN13 code** 8015747029544

## Packaging Information

|                                  |                   |
|----------------------------------|-------------------|
| <b>Sub-packaging weight</b>      | 2,55 kg           |
| <b>Sub-packaging description</b> | Plastic packaging |
| <b>Sub-packaging quantity</b>    | 5 Pcs             |
| <b>Sub-packaging EAN barcode</b> | 8015747280938     |

Part number

# CMAP 16 LS29



Catalogue drawings

## CMP L CMAP L - MMP L MMAP L



## CMP LS CMAP LS - MMP LS MMAP LS

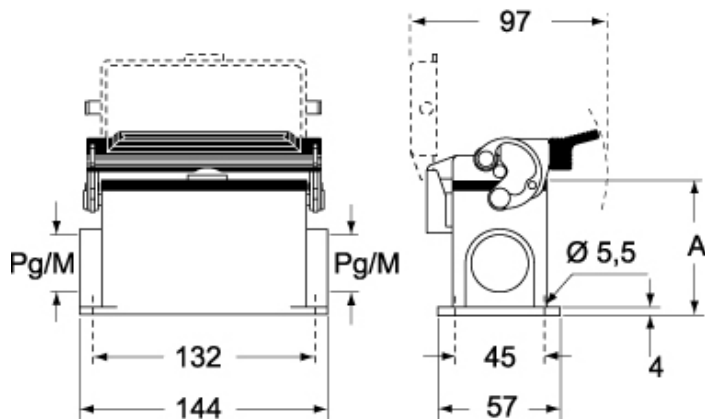

|                          | <b>A</b> |
|--------------------------|----------|
| <b>CMP L / MMP L</b>     | 63       |
| <b>CMAP L / MMAP L</b>   | 80       |
| <b>CMP LS / MMP LS</b>   | 63       |
| <b>CMAP LS / MMAP LS</b> | 80       |