

Part number

CMAF 16.21



Hood, 830V series, with 4 pegs, Pg21 frontal cable entry, size "104.27", high construction

Product description	
Product type	Hood
Series	830V
Closing type	With 4 pegs
Size	Size 104.27
Cable entry	Frontal cable entry with adapter Pg21
Specification	High construction
Technical data	
IP degree of protection	IP65 / IP66 / IP69
Further technical details	
Weight	276,00 g
Operating temperature range (min, max)	-40°C...+125°C

Material properties	
Colour	RAL 7040 grey
RoHs conformity	Compliant with exemption 6(c): copper alloy containing up to 4% lead by weight
China RoHs - EFUP	50
REACH SVHC substances	Yes Lead
SCIP number	15deaf78-e939-4401-a0b0-e2228ca32a03
Approvals / Standards	
Certifications	DNV, BV
UL	ECBT2
cUL	ECBT8
General ordering information	
EAN13 code	8015747028615
Packaging Information	
Sub-packaging weight	1,38 kg
Sub-packaging description	Plastic packaging
Sub-packaging quantity	5 Pcs
Sub-packaging EAN barcode	8015747104159

Part number

CMAF 16.21



Catalogue drawings

**CMO [CMAO] CMV (CMAV) - MMO [MMAO]
MMV (MMAV)**

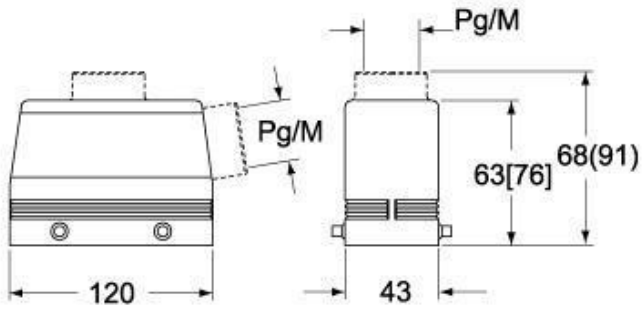

CMV G (CMAV G) - MMV G (MMAV G) - [MMFV G]

