

Part number

CKAT 03.3 V



Hood, CKA series, with 2 pegs, 3/8" NPT top cable entry, size "21.21"

Product description		Material properties	
Product type	Hood	Main material	Zinc die-cast
Series	CKA	Colour	RAL 7040 grey
Closing type	With 2 pegs	RoHs conformity	Compliant
Size	Size "21.21"	China RoHs - EFUP	E
Cable entry	Top cable entry 3/8" NPT	REACH SVHC substances	No
Technical data		Approvals / Standards	
IP degree of protection	IP44 - IP66 / IP67 / IP69 with CKR 65 (D)	UL	ECBT2
Further technical details		cUL	ECBT8
Further technical details		General ordering information	
Weight	66,50 g	EAN13 code	8015747027335
Operating temperature range (min, max)	-40°C...+125°C	Packaging Information	
		Packaging length	330,00 mm
		Packaging height	230,00 mm
		Packaging width	205,00 mm
		Packaging weight	6,75 kg
		Packaging volume	15,56 dm ³
		Packaging description	Carton box
		Packaging quantity	100 Pcs
		Packaging EAN code	8015747234276
		Sub-packaging length	185,00 mm
		Sub-packaging height	40,00 mm
		Sub-packaging width	155,00 mm
		Sub-packaging weight	0,68 kg
		Sub-packaging volume	1,15 dm ³
		Sub-packaging description	Carton box
		Sub-packaging quantity	10 Pcs
		Sub-packaging EAN barcode	8015747027342

Part number

CKAT 03.3 V



Catalogue drawings

CKA VS - MKA V

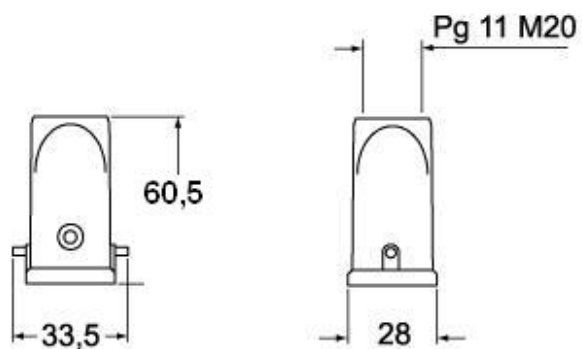

CKA VAS - MKA VA

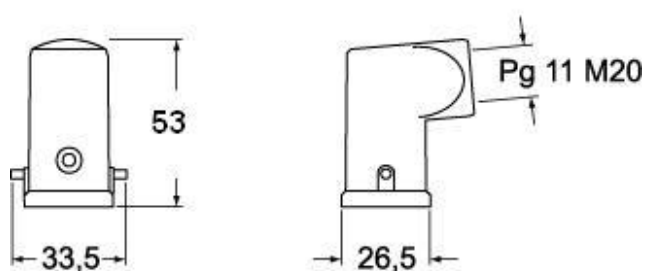

CKA VAS - MKA VA

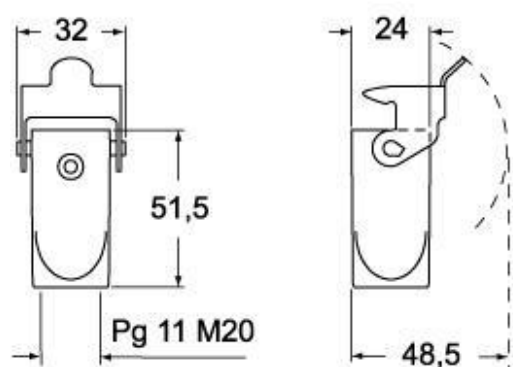

CKAX VGS - MKAX VG

