

Part number

CAP 24.29



Surface mounting housing, C-TYPE series, with 2 levers, Pg29 cable entry, size "104.27", high construction

Product description

Product type	Surface mounting housing
Series	C-TYPE
Closing type	With 2 levers
Size	Size 104.27
Cable entry	With cable entry Pg29
Specification	High construction

Technical data

IP degree of protection	IP65 / IP66 / IP69
--------------------------------	--------------------

Further technical details

Weight	470,00 g
Operating temperature range (min, max)	-40°C...+125°C

Material properties

Other materials	Lever: Stainless steel, polyamide (PA) Gasket: NBR
Colour	RAL 7040 grey
RoHs conformity	Compliant
China RoHs - EFUP	E
REACH SVHC substances	No

Approvals / Standards

Certifications	DNV, BV
UL	ECBT2
cUL	ECBT8

General ordering information

EAN13 code	8015747008679
-------------------	---------------

Packaging Information

Packaging length	475,00 mm
Packaging height	220,00 mm
Packaging width	200,00 mm
Packaging weight	5,00 kg
Packaging volume	20,90 dm ³
Packaging description	Carton box
Packaging quantity	10 Pcs
Packaging EAN code	8015747223645
Sub-packaging weight	2,50 kg
Sub-packaging description	Plastic packaging
Sub-packaging quantity	5 Pcs
Sub-packaging EAN barcode	8015747008686

Part number

CAP 24.29



Catalogue drawings

CHP CAP - MHP MAP

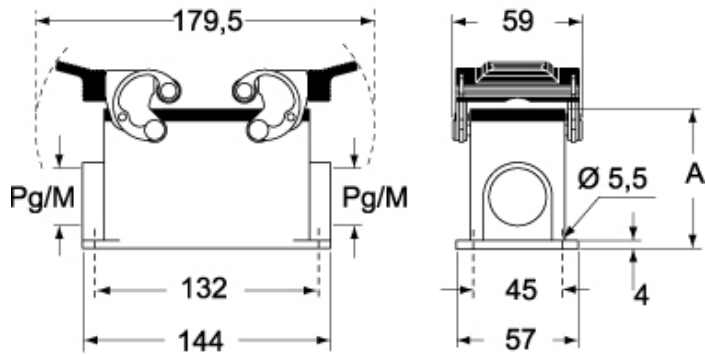

CHP CS/CP CAP CS/CP - MHP CS/CP MAP CS/CP

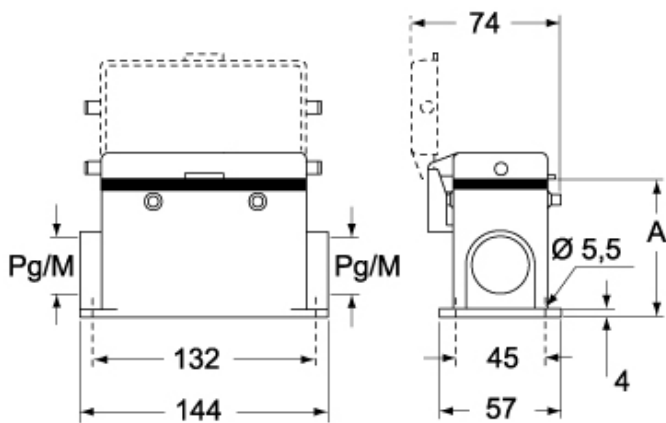

	A
CHP / MHP	63
CAP / MAP	80
CHP CS / MHP CS	63
CAP CS / MAP CS	80
CHP CP / MHP CP	63
CAP CP / MAP CP	80