

Part number

TMAV 16G40B



Hood, T-TYPE series, with 2 levers, M40 top cable entry, size "77.27", with integrated protective PE jumpers

Product description	
Product type	Hood
Series	T-TYPE
Closing type	With 2 levers
Size	Size 77.27
Cable entry	Top cable entry M40
Specification	With integrated protective PE jumpers
Technical data	
IP degree of protection	IP65
Further technical details	
Weight	0,50 g
Operating temperature range (min, max)	-40°C ... +90°C

Material properties	
Main material	Polypropylene (PP)
Other materials	Lever: Polyamide (PA) Gasket: polyurethane (PUR) PE jumpers: galvanized brass
Colour	RAL 7012 grey, RAL 7001 grey
RoHs conformity	Compliant
China RoHs - EFUP	E
REACH SVHC substances	No
Approvals / Standards	
UL	ECBT2
cUL	ECBT8
General ordering information	
EAN13 code	8015747277594
eCl@ss 8.1	27440202
ETIM 7.0	EC000437
Packaging Information	
Packaging length	290,00 mm
Packaging height	250,00 mm
Packaging width	360,00 mm
Packaging volume	26,10 dm ³
Packaging description	Carton box
Packaging quantity	20 Pcs
Packaging EAN code	8015747302630
Sub-packaging description	Plastic packaging
Sub-packaging quantity	5 Pcs
Sub-packaging EAN barcode	8015747302647

Part number

TMAV 16G40B



Catalogue drawings

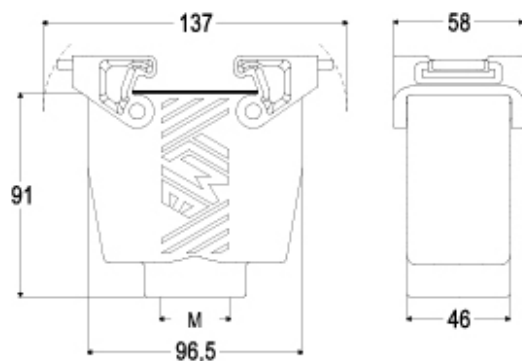

Notes