

Part number

TMAV 10 G25



Hood, T-TYPE series, with 2 levers, M25 top cable entry, size "57.27"

Product description		Material properties	
Product type	Hood	Main material	Polypropylene (PP)
Series	T-TYPE	Other materials	Lever: Polyamide (PA) Gasket: polyurethane (PUR)
Closing type	With 2 levers	Colour	RAL 7012 grey, RAL 7001 grey
Size	Size 57.27	RoHs conformity	Compliant
Cable entry	Top cable entry M25	China RoHs - EFUP	E
Technical data		REACH SVHC substances	No
IP degree of protection	IP65	Approvals / Standards	
Further technical details		UL	ECBT2
Weight	140,00 g	cUL	ECBT8
Operating temperature range (min, max)	-40°C ... +90°C	General ordering information	
		EAN13 code	8015747209069
		eCl@ss 8.1	27440202
		ETIM 7.0	EC000437
		Packaging Information	
		Packaging length	310,00 mm
		Packaging height	220,00 mm
		Packaging width	240,00 mm
		Packaging weight	2,80 kg
		Packaging volume	16,37 dm ³
		Packaging description	Carton box
		Packaging quantity	20 Pcs
		Packaging EAN code	8015747260787
		Sub-packaging weight	0,70 kg
		Sub-packaging description	Plastic packaging
		Sub-packaging quantity	5 Pcs
		Sub-packaging EAN barcode	8015747209144

Part number

TMAV 10 G25



Catalogue drawings

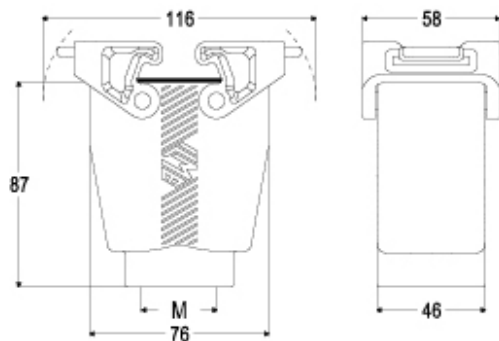

Notes