

Part number

TMAV 06 L25



Hood, T-TYPE series, with 2 pegs, M25 top cable entry, size "44.27", high construction

Product description

Product type	Hood
Series	T-TYPE
Closing type	With 2 pegs
Size	Size 44.27
Cable entry	Top cable entry M25
Specification	High construction

Technical data

IP degree of protection IP65

Further technical details

Weight	97,00 g
Operating temperature range (min, max)	-40°C ... +90°C

Material properties

Main material	Polypropylene (PP)
Colour	RAL 7012 grey
RoHs conformity	Compliant
China RoHs - EFUP	E
REACH SVHC substances	No

Approvals / Standards

UL	ECBT2
cUL	ECBT8

General ordering information

EAN13 code	8015747168731
eCl@ss 8.1	27440202
ETIM 7.0	EC000437

Packaging Information

Packaging length	270,00 mm
Packaging height	210,00 mm
Packaging width	165,00 mm
Packaging weight	2,10 kg
Packaging volume	9,36 dm ³
Packaging description	Carton box
Packaging quantity	20 Pcs
Packaging EAN code	8015747171243
Sub-packaging weight	0,53 kg
Sub-packaging description	Plastic packaging
Sub-packaging quantity	5 Pcs
Sub-packaging EAN barcode	8015747171250

Part number

TMAV 06 L25



Catalogue drawings

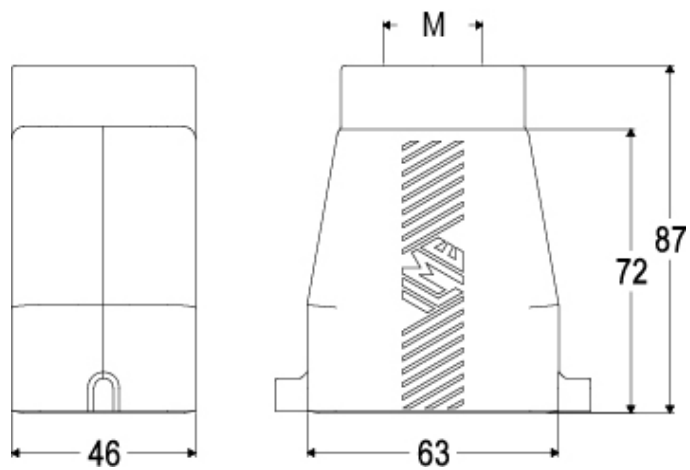

Notes