

Part number

TM 1114 PF

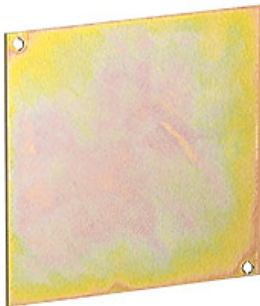

Fixing plate, TM series, for TM 1114 DB junction boxes



Product description		General ordering information	
Product type	Fixing plate	EAN13 code	8015747089241
Series	TM	Packaging Information	
Specification	For TM 1114 DB junction boxes	Sub-packaging weight	0,11 kg
Further technical details		Sub-packaging description	Plastic bag
Weight	113,50 g	Sub-packaging quantity	1 Pcs
Operating temperature range (min, max)	-40°C ... +125°C	Sub-packaging EAN barcode	8015747089258

Part number

TM 1114 PF



Catalogue drawings

TM 1125 PF

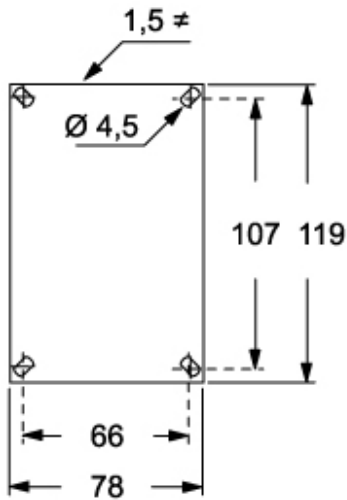

TM xx14 PF

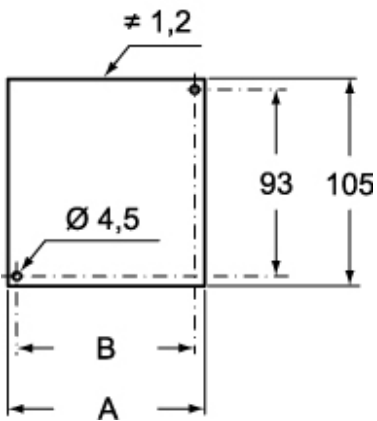

Notes