

Part number

TAVC 24 G40



Hood, T-TYPE/C series, with 2 levers, M40 top cable entry, size "104.27"

Product description

Product type	Hood
Series	T-TYPE/C
Closing type	With 2 levers
Size	Size 104.27
Cable entry	Top cable entry M40

Technical data

IP degree of protection IP66 / IP69

Further technical details

Weight	170,00 g
Operating temperature range (min, max)	-50°C ... +70°C

Material properties

Main material	Polypropylene (PP)
Other materials	Lever: Polypropylene (PP) Gasket: Silicone rubber
Colour	RAL 7012 grey, RAL 5005 blue
RoHs conformity	Compliant
China RoHs - EFUP	E
REACH SVHC substances	No

General ordering information

EAN13 code	8015747212311
eCl@ss 8.1	27440202
ETIM 7.0	EC000437

Packaging Information

Packaging length	290,00 mm
Packaging height	250,00 mm
Packaging width	360,00 mm
Packaging weight	3,46 kg
Packaging volume	26,10 dm ³
Packaging description	Carton box
Packaging quantity	20 Pcs
Packaging EAN code	8015747260978
Sub-packaging weight	0,87 kg
Sub-packaging description	Plastic packaging
Sub-packaging quantity	5 Pcs
Sub-packaging EAN barcode	8015747212489

Part number

TAVC 24 G40



Catalogue drawings

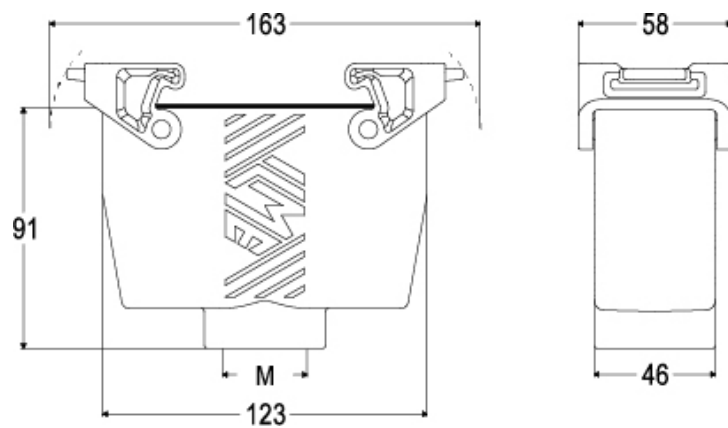

Notes