

Part number

# TAVC 16 G40



Hood, T-TYPE/C series, with 2 levers, M40 top cable entry, size "77.27"

## Product description

<b>Product type</b>	Hood
<b>Series</b>	T-TYPE/C
<b>Closing type</b>	With 2 levers
<b>Size</b>	Size 77.27
<b>Cable entry</b>	Top cable entry M40

## Technical data

**IP degree of protection** IP66 / IP69

## Further technical details

<b>Weight</b>	147,00 g
<b>Operating temperature range (min, max)</b>	-50°C ... +70°C

## Material properties

<b>Main material</b>	Polypropylene (PP)
<b>Other materials</b>	Lever: Polypropylene (PP) Gasket: Silicone rubber
<b>Colour</b>	RAL 7012 grey, RAL 5005 blue
<b>RoHs conformity</b>	Compliant
<b>China RoHs - EFUP</b>	E
<b>REACH SVHC substances</b>	No

## General ordering information

<b>EAN13 code</b>	8015747212298
<b>eCl@ss 8.1</b>	27440202
<b>ETIM 7.0</b>	EC000437

## Packaging Information

<b>Packaging length</b>	290,00 mm
<b>Packaging height</b>	250,00 mm
<b>Packaging width</b>	360,00 mm
<b>Packaging weight</b>	3,04 kg
<b>Packaging volume</b>	26,10 dm <sup>3</sup>
<b>Packaging description</b>	Carton box
<b>Packaging quantity</b>	20 Pcs
<b>Packaging EAN code</b>	8015747260954
<b>Sub-packaging weight</b>	0,76 kg
<b>Sub-packaging description</b>	Plastic packaging
<b>Sub-packaging quantity</b>	5 Pcs
<b>Sub-packaging EAN barcode</b>	8015747212465

Part number

# TAVC 16 G40



Catalogue drawings

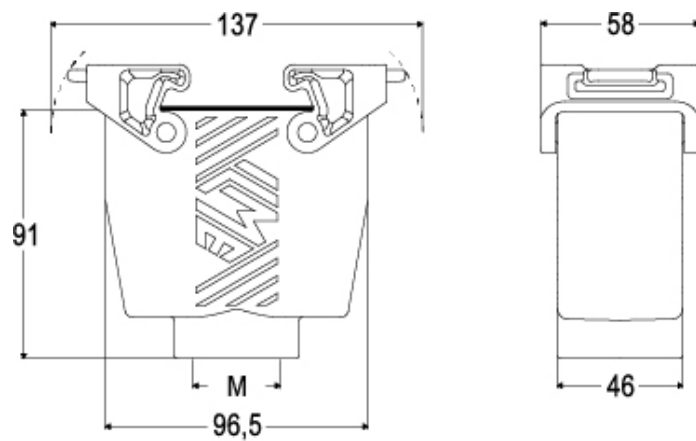

Notes