

Part number

# TAPH10.225B



Surface mounting housing, T-TYPE /H series, with 2 levers, M25 x 2 cable entry, size "57.27", with integrated protective PE jumpers

Product description		Material properties	
<b>Product type</b>	Surface mounting housing	<b>Main material</b>	Polypropylene (PP)
<b>Series</b>	T-TYPE /H	<b>Other materials</b>	Lever: Polypropylene (PP), metal-detectable Gasket: HNBR PE jumpers: galvanized brass
<b>Closing type</b>	With 2 levers	<b>Colour</b>	RAL 7012 grey, RAL 5005 blue
<b>Size</b>	Size 57.27	<b>RoHs conformity</b>	Compliant
<b>Cable entry</b>	With cable entry M25 x 2	<b>China RoHs - EFUP</b>	E
<b>Specification</b>	With integrated protective PE jumpers	<b>REACH SVHC substances</b>	No
Technical data		General ordering information	
<b>IP degree of protection</b>	IP66 / IP69	<b>EAN13 code</b>	8015747278003
Further technical details		Packaging Information	
<b>Weight</b>	0,50 g	<b>Packaging length</b>	310,00 mm
<b>Operating temperature range (min, max)</b>	-40°C ... +70°C	<b>Packaging height</b>	220,00 mm
		<b>Packaging width</b>	240,00 mm
		<b>Packaging volume</b>	16,37 dm <sup>3</sup>
		<b>Packaging description</b>	Carton box
		<b>Packaging quantity</b>	20 Pcs
		<b>Packaging EAN code</b>	8015747298896
		<b>Sub-packaging description</b>	Plastic packaging
		<b>Sub-packaging quantity</b>	5 Pcs
		<b>Sub-packaging EAN barcode</b>	8015747298902

Part number

# TAPH10.225B



Catalogue drawings

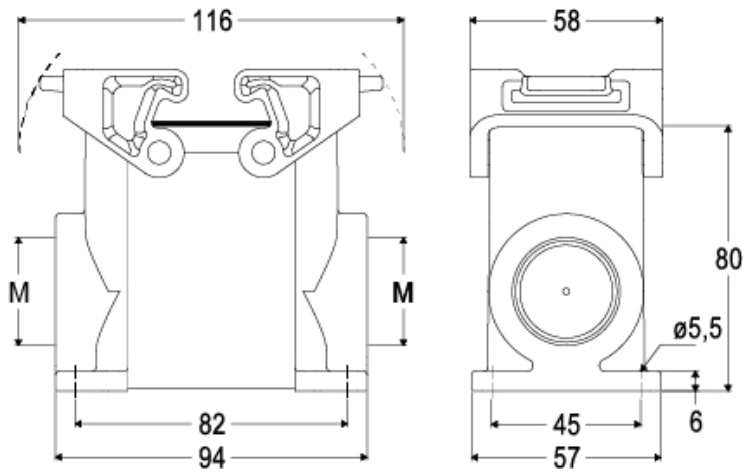

Notes