

Part number

TAPC24.240B



Surface mounting housing, T-TYPE/C series, with 2 levers, M40 x 2 cable entry, size "104.27", with integrated protective PE jumpers

Product description	
Product type	Surface mounting housing
Series	T-TYPE/C
Closing type	With 2 levers
Size	Size 104.27
Cable entry	With cable entry M40 x 2
Specification	With integrated protective PE jumpers
Technical data	
IP degree of protection	IP66 / IP69
Further technical details	
Weight	0,50 g
Operating temperature range (min, max)	-50°C ... +70°C

Material properties	
Main material	Polypropylene (PP)
Other materials	Lever: Polypropylene (PP) Gasket: Silicone rubber PE jumpers: galvanized brass
Colour	RAL 7012 grey, RAL 5005 blue
RoHs conformity	Compliant
China RoHs - EFUP	E
REACH SVHC substances	No
General ordering information	
EAN13 code	8015747278379
Packaging Information	
Packaging length	330,00 mm
Packaging height	220,00 mm
Packaging width	310,00 mm
Packaging volume	22,51 dm ³
Packaging description	Carton box
Packaging quantity	20 Pcs
Packaging EAN code	8015747298728
Sub-packaging description	Plastic packaging
Sub-packaging quantity	5 Pcs
Sub-packaging EAN barcode	8015747298711

Part number

TAPC24.240B



Catalogue drawings

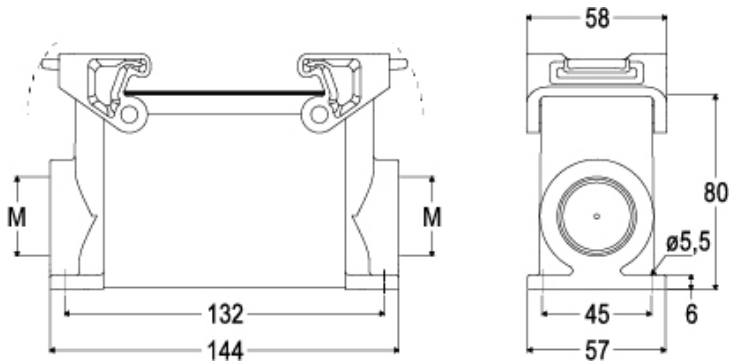

Notes