

Part number

# TAPC 16.40B



Surface mounting housing, T-TYPE/C series, with 2 levers, M40 cable entry, size "77.27", with integrated protective PE jumpers

Product description	
<b>Product type</b>	Surface mounting housing
<b>Series</b>	T-TYPE/C
<b>Closing type</b>	With 2 levers
<b>Size</b>	Size 77.27
<b>Cable entry</b>	With cable entry M40
<b>Specification</b>	With integrated protective PE jumpers
Technical data	
<b>IP degree of protection</b>	IP66 / IP69
Further technical details	
<b>Weight</b>	0,50 g
<b>Operating temperature range (min, max)</b>	-50°C ... +70°C

Material properties	
<b>Main material</b>	Polypropylene (PP)
<b>Other materials</b>	Lever: Polypropylene (PP) Gasket: Silicone rubber PE jumpers: galvanized brass
<b>Colour</b>	RAL 7012 grey, RAL 5005 blue
<b>RoHs conformity</b>	Compliant
<b>China RoHs - EFUP</b>	E
<b>REACH SVHC substances</b>	No
General ordering information	
<b>EAN13 code</b>	8015747278317
Packaging Information	
<b>Packaging length</b>	310,00 mm
<b>Packaging height</b>	220,00 mm
<b>Packaging width</b>	280,00 mm
<b>Packaging volume</b>	19,10 dm <sup>3</sup>
<b>Packaging description</b>	Carton box
<b>Packaging quantity</b>	20 Pcs
<b>Packaging EAN code</b>	8015747298377
<b>Sub-packaging description</b>	Plastic packaging
<b>Sub-packaging quantity</b>	5 Pcs
<b>Sub-packaging EAN barcode</b>	8015747298384

Part number

# TAPC 16.40B



Catalogue drawings

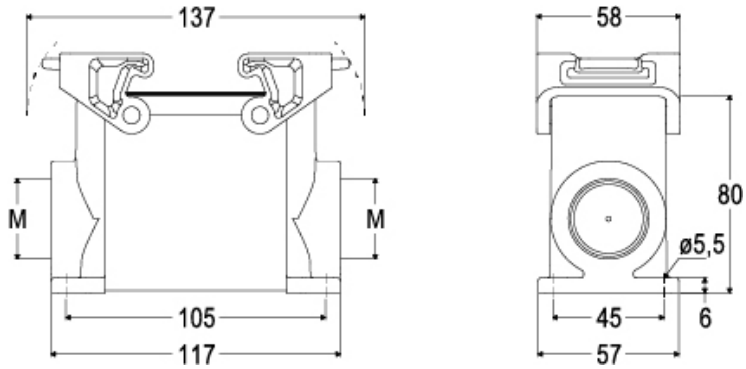

Notes