

Part number

TAPC 10.232

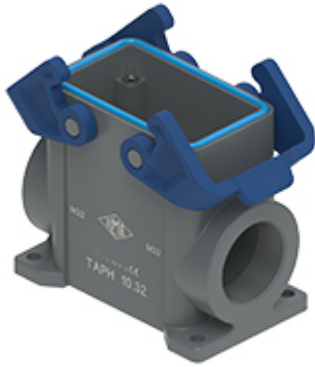

Surface mounting housing, T-TYPE/C series,
with 2 levers, M32x2 cable entry, size "57.27"

Product description

Product type	Surface mounting housing
Series	T-TYPE/C
Closing type	With 2 levers
Size	Size 57.27
Cable entry	With cable entry M32 x 2

Technical data

IP degree of protection IP66 / IP69

Further technical details

Operating temperature range (min, max) -50°C ... +70°C

Material properties

Main material	Polypropylene (PP)
Other materials	Lever: Polypropylene (PP) Gasket: Silicone rubber
Colour	RAL 7012 grey, RAL 5005 blue
RoHs conformity	Compliant
China RoHs - EFUP	E
REACH SVHC substances	No

General ordering information

EAN13 code	8015747184922
eCl@ss 8.1	27440202
ETIM 7.0	EC000437

Part number

TAPC 10.232



Catalogue drawings

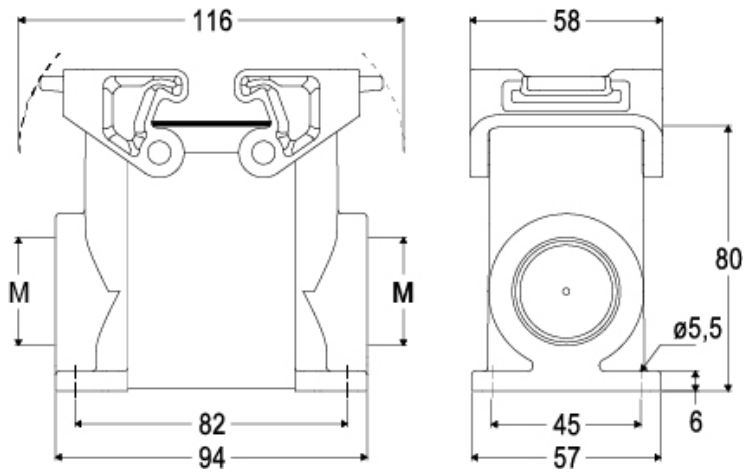

Notes