

Part number

SQE 1644



Interlocked switched socket-outlet, SQE series, 3 poles + PE, 4 h (yellow), 16 A, 100 ÷ 130 V, without fuse-carrier

Product description	
Product type	Interlocked switched socket-outlet
Series	SQE
N. of poles	3 poles + 
Clock position	4
Size	Socket fixing centre distance 88 x 230 mm
Specification	Without fuse-carrier
Technical data	
Current	16 A
Voltage	100 ÷ 130 V
IP degree of protection	IP44
Further technical details	
Weight	380,00 g
Operating temperature range (min, max)	-25°C ... +40°C
IK rating (impact degree of protection)	IK08

Material properties	
Colour	RAL 7035 grey, RAL 1021 yellow
RoHs conformity	Compliant with exemption 6(c): copper alloy containing up to 4% lead by weight
China RoHs - EFUP	50
REACH SVHC substances	Yes Lead
SCIP number	Ce861c8d-b979-403b-96d9-80aef6dc281d
Approvals / Standards	
Reference standard	EN 60309-1, -2 e -4
General ordering information	
EAN13 code	8015747085465
Packaging Information	
Sub-packaging length	116,00 mm
Sub-packaging height	103,00 mm
Sub-packaging width	230,00 mm
Sub-packaging weight	0,38 kg
Sub-packaging volume	2,75 dm ³
Sub-packaging description	Carton box
Sub-packaging quantity	1 Pcs
Sub-packaging EAN barcode	8015747085472

Part number

SQE 1644



Catalogue drawings

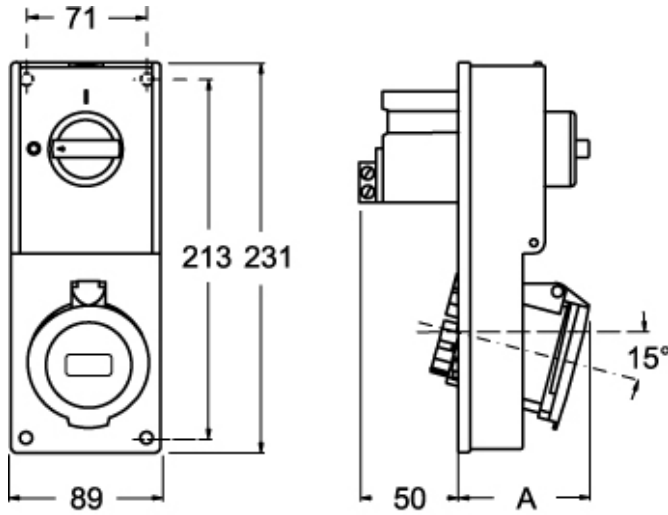

Catalogue drawings

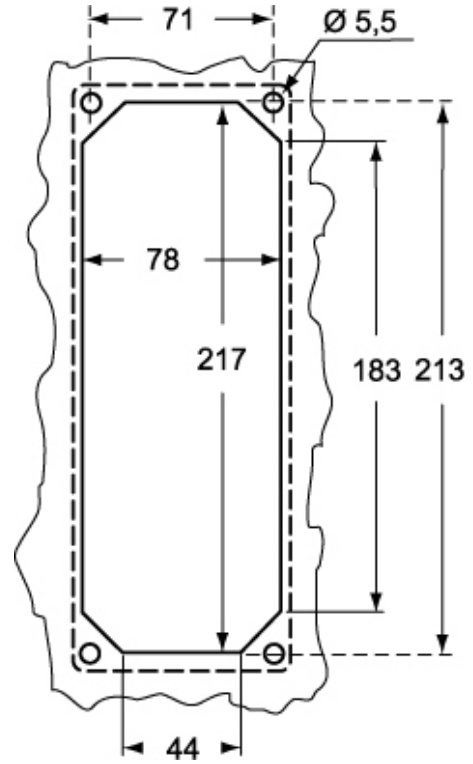

SQE		A
16A	2P+⊕	64
	3P+⊕	65
	3P+N+⊕	67

Notes