

Part number

SQ 16104



Interlocked switched socket-outlet, SQ series,
3 poles + PE, 10 h (green), 16 A, > 50 V,
without fuse-carrier

Product description

Product type	Interlocked switched socket-outlet
Series	SQ
N. of poles	3 poles + 
Clock position	10
Specification	Without fuse-carrier

Technical data

Current	16 A
Voltage	> 50 V
IP degree of protection	IP44

Further technical details

Operating temperature range (min, max)	-25°C ... +40°C
IK rating (impact degree of protection)	IK08

Material properties

Colour	RAL 7035 grey, RAL 6017 green
---------------	-------------------------------

Approvals / Standards

Reference standard	EN 60309-1, -2 e -4
---------------------------	---------------------

General ordering information

EAN13 code	8015747159234
-------------------	---------------

Part number

SQ 16104



Catalogue drawings



SQ		A
16A	2P+⊕	59
	3P+⊕	63
	3P+N+⊕	63

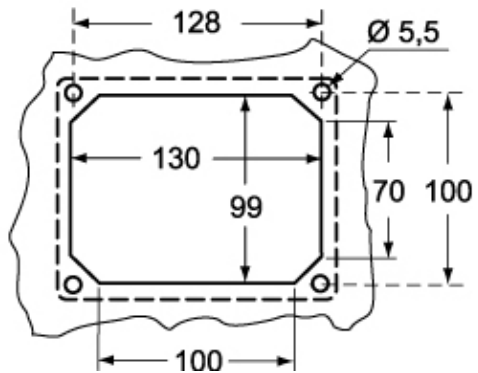

Notes