

Part number

SIM3D 0.2C

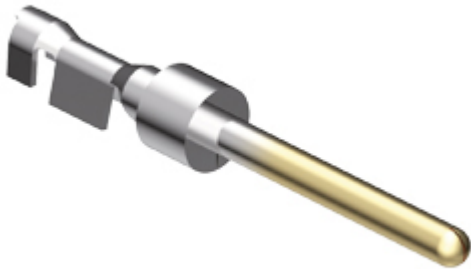

Male crimp contact, SI series, 5 A, stamped gold plated, wire cross section 0,08 - 0,21 mm², AWG 28 - 24, coil packaging, for 50 mating cycles

Product description

Product type	Crimp contact
Series	SI
Gender	Male
Specification	Coil packaging For 50 mating cycles

Technical data

Current	5 A
Wire cross-section	0,08 mm ² - 0,21 mm ²
AWG size	28 - 24
Contact type	Stamped gold plated

Further technical details

Contact resistance	≤ 10 mΩ
Weight	0,21 g
Conductors stripping length	3 mm

Material properties

RoHS conformity	Compliant
China RoHS - EFUP	E
REACH SVHC substances	No

Approvals / Standards

Certifications	EAC
UL	ECBT2
cUL	ECBT8

General ordering information

EAN13 code	8015747276962
eCl@ss 8.1	27440204
ETIM 7.0	EC000796

Packaging Information

Packaging weight	0,12 kg
Packaging description	Plastic bag
Packaging quantity	500 Pcs
Packaging EAN code	8015747190183

Part number

SIM3D 0.2C



Catalogue drawings

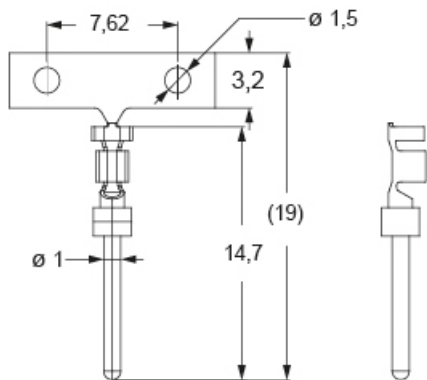

SIM..D C



Notes

California Proposition 65 Information



WARNING

This product can expose you to nickel compounds, known to the State of California to cause cancer and/or reproductive toxicity. For more information go to www.P65Warnings.ca.gov.