

Part number

# SIF3D 0.2

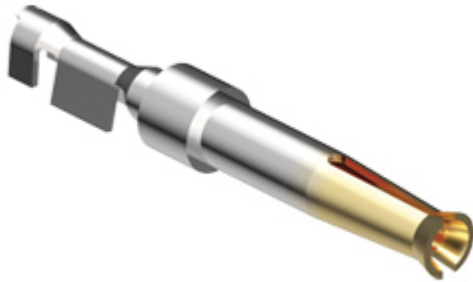

Female crimp contact, SI series, 5 A, stamped gold plated, wire cross section 0,08 - 0,21 mm<sup>2</sup>, AWG 28 - 24, loose parts, for 50 mating cycles

Product description		Material properties	
<b>Product type</b>	Crimp contact	<b>RoHs conformity</b>	Compliant
<b>Series</b>	SI	<b>China RoHs - EFUP</b>	E
<b>Gender</b>	Female	<b>REACH SVHC substances</b>	No
<b>Specification</b>	Loose parts For 50 mating cycles	<b>Approvals / Standards</b>	
<b>Technical data</b>		<b>Certifications</b>	EAC
<b>Current</b>	5 A	<b>UL</b>	ECBT2
<b>Wire cross-section</b>	0,08 mm <sup>2</sup> - 0,21 mm <sup>2</sup>	<b>cUL</b>	ECBT8
<b>AWG size</b>	28 - 24	<b>General ordering information</b>	
<b>Contact type</b>	Stamped gold plated	<b>EAN13 code</b>	8015747276900
<b>Further technical details</b>		<b>eCl@ss 8.1</b>	27440204
<b>Contact resistance</b>	≤ 10 mΩ	<b>ETIM 7.0</b>	EC000796
<b>Weight</b>	0,11 g	<b>Packaging Information</b>	
<b>Conductors stripping length</b>	3 mm	<b>Packaging length</b>	112,00 mm
		<b>Packaging height</b>	95,00 mm
		<b>Packaging width</b>	117,00 mm
		<b>Packaging weight</b>	0,36 kg
		<b>Packaging volume</b>	1,24 dm <sup>3</sup>
		<b>Packaging description</b>	Carton box
		<b>Packaging quantity</b>	1600 Pcs
		<b>Packaging EAN code</b>	8015747197601
		<b>Sub-packaging length</b>	50,00 mm
		<b>Sub-packaging height</b>	44,00 mm
		<b>Sub-packaging width</b>	50,00 mm
		<b>Sub-packaging weight</b>	0,05 kg
		<b>Sub-packaging volume</b>	0,11 dm <sup>3</sup>
		<b>Sub-packaging description</b>	Plastic box
		<b>Sub-packaging quantity</b>	200 Pcs
		<b>Sub-packaging EAN barcode</b>	8015747197700

Part number

# SIF3D 0.2



## Catalogue drawings

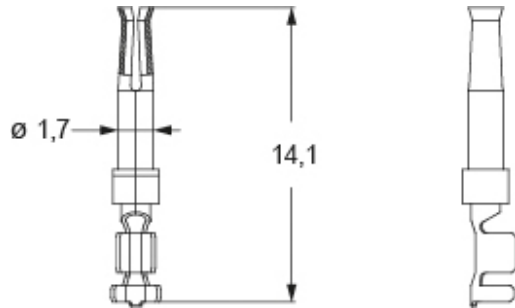

## Notes

### California Proposition 65 Information



### WARNING

This product can expose you to nickel compounds, known to the State of California to cause cancer and/or reproductive toxicity. For more information go to [www.P65Warnings.ca.gov](http://www.P65Warnings.ca.gov).