

Part number

SIF2D 0.5C

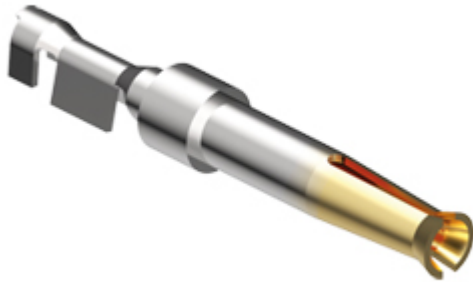

Female crimp contact, SI series, 5 A, stamped gold plated, wire cross section 0,21 - 0,52 mm², AWG 24 - 20, coil packaging, for 250 mating cycles

Product description

Product type	Crimp contact
Series	SI
Gender	Female
Specification	Coil packaging For 250 mating cycles

Technical data

Current	5 A
Wire cross-section	0,21 mm ² - 0,52 mm ²
AWG size	24 - 20
Contact type	Stamped gold plated

Further technical details

Contact resistance	≤ 10 mΩ
Weight	0,24 g
Conductors stripping length	3 mm

Material properties

RoHS conformity	Compliant
China RoHS - EFUP	E
REACH SVHC substances	No

Approvals / Standards

Certifications	EAC
UL	ECBT2
cUL	ECBT8

General ordering information

EAN13 code	8015747272360
eCl@ss 8.1	27440204
ETIM 7.0	EC000796

Packaging Information

Packaging weight	0,14 kg
Packaging description	Plastic bag
Packaging quantity	500 Pcs
Packaging EAN code	8015747273985

Part number

SIF2D 0.5C



Catalogue drawings

SIF..D C

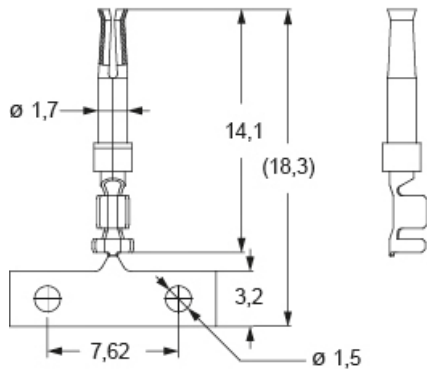

Notes

California Proposition 65 Information



WARNING

This product can expose you to nickel compounds, known to the State of California to cause cancer and/or reproductive toxicity. For more information go to www.P65Warnings.ca.gov.