

Part number

SIF2D 0.2R

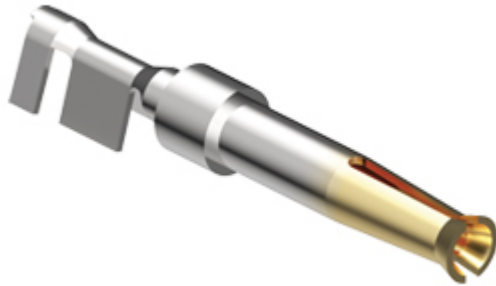

Female crimp contact, SI series, 5 A, stamped gold plated, wire cross section 0,08 - 0,21 mm², AWG 28 - 24, reel packaging, for 250 mating cycles

Product description

Product type	Crimp contact
Series	SI
Gender	Female
Specification	Reel packaging For 250 mating cycles

Technical data

Current	5 A
Wire cross-section	0,08 mm ² - 0,21 mm ²
AWG size	28 - 24
Contact type	Stamped gold plated

Further technical details

Contact resistance	≤ 10 mΩ
Weight	0,19 g
Conductors stripping length	3 mm

Material properties

RoHS conformity	Compliant
China RoHS - EFUP	E
REACH SVHC substances	No

Approvals / Standards

Certifications	EAC
UL	ECBT2
cUL	ECBT8

General ordering information

EAN13 code	8015747272391
eCl@ss 8.1	27440204
ETIM 7.0	EC000796

Packaging Information

Packaging weight	2,15 kg
Packaging description	Plastic bag
Packaging quantity	10000 Pcs
Packaging EAN code	8015747273992

Part number

SIF2D 0.2R



Catalogue drawings

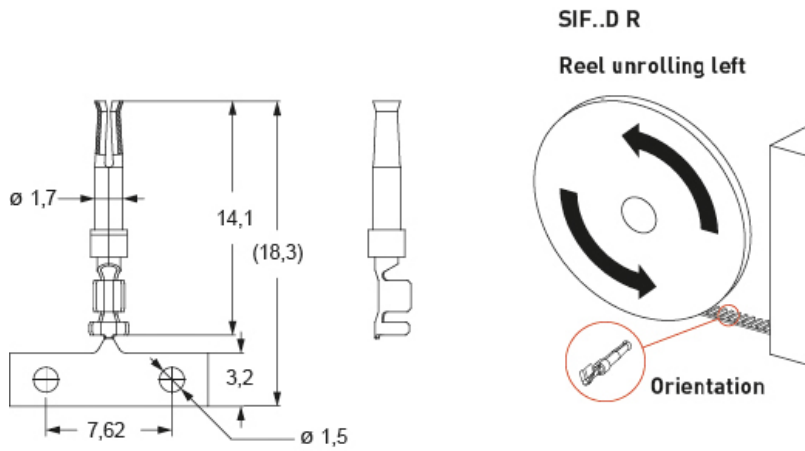

Notes

California Proposition 65 Information



WARNING

This product can expose you to nickel compounds, known to the State of California to cause cancer and/or reproductive toxicity. For more information go to www.P65Warnings.ca.gov.