

Part number

RFO 06 L32



Hood, HNM - High Number of Matings series, with 2 pegs, M32 side cable entry without adapter, size "44.27", high construction

Product description		Material properties	
Product type	Hood	Colour	RAL 7040 grey
Series	HNM - High Number of Matings	RoHs conformity	Compliant
Closing type	With 2 pegs	China RoHs - EFUP	E
Size	Size 44.27	REACH SVHC substances	No
Cable entry	Side cable entry M32	Approvals / Standards	
Specification	High construction	UL	ECBT2
Technical data		cUL	ECBT8
IP degree of protection	IP65 / IP66 / IP69	General ordering information	
Further technical details		EAN13 code	8015747235082
Weight	161,00 g	eCl@ss 8.1	27440202
Operating temperature range (min, max)	-40°C...+125°C	ETIM 7.0	EC000437
		Packaging Information	
		Packaging length	180,00 mm
		Packaging height	105,00 mm
		Packaging width	270,00 mm
		Packaging weight	1,75 kg
		Packaging volume	5,10 dm ³
		Packaging description	Carton box
		Packaging quantity	10 Pcs
		Packaging EAN code	8015747243261
		Sub-packaging weight	0,88 kg
		Sub-packaging description	Plastic packaging
		Sub-packaging quantity	5 Pcs
		Sub-packaging EAN barcode	8015747235099

Part number

RFO 06 L32



Catalogue drawings

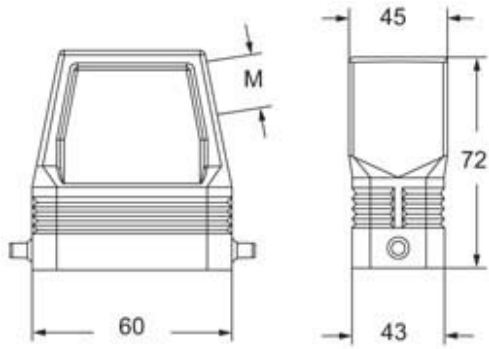

Notes