

Part number

RDDM 72



Male insert, RDD series, crimp connection, 72 poles + PE, 10 A 250 V 4 kV 2, size "77.27", HNM - High Number of Matings version

Product description

Product type	Insert
Series	RDD
Connection type	Crimp connection
Gender	Male
N. of poles	72 poles + 
Size	Size 77.27
Specification	HNM - High Number of Matings version

Technical data

Current	10 A
Voltage	250 V
Rated impulse withstand voltage	4 kV
Pollution degree	2
Rated voltage according to UL/CSA	600 V
IP degree of protection	IP20 without enclosure, IP65/IP66/IP68/IP69 with enclosure

Further technical details

Mating cycles	≥ 10000
Insulation resistance	≥ 10 GΩ
Contact resistance	≤ 3 mΩ
Weight	58,00 g
Operating temperature range (min, max)	-40 °C ... +125 °C
UL 94 flammability rating	V-0

Material properties

Main material	Polycarbonate (PC)
Colour	RAL 7032 grey
RoHs conformity	Compliant
China RoHs - EFUP	E
REACH SVHC substances	No

Approvals / Standards

Certifications	DNV, BV, EAC
UL	ECBT2
cUL	ECBT8

General ordering information

EAN13 code	8015747255431
eCl@ss 8.1	27440205
ETIM 7.0	EC000438

Packaging Information

Packaging length	230,00 mm
Packaging height	110,00 mm
Packaging width	180,00 mm
Packaging weight	2,04 kg
Packaging volume	4,55 dm ³
Packaging description	Carton box
Packaging quantity	30 Pcs
Packaging EAN code	8015747257138
Sub-packaging length	87,00 mm
Sub-packaging height	36,00 mm
Sub-packaging width	180,00 mm
Sub-packaging weight	0,34 kg
Sub-packaging volume	0,56 dm ³
Sub-packaging description	Carton tray
Sub-packaging quantity	5 Pcs
Sub-packaging EAN barcode	8015747257145

Part number

RDDM 72



Catalogue drawings

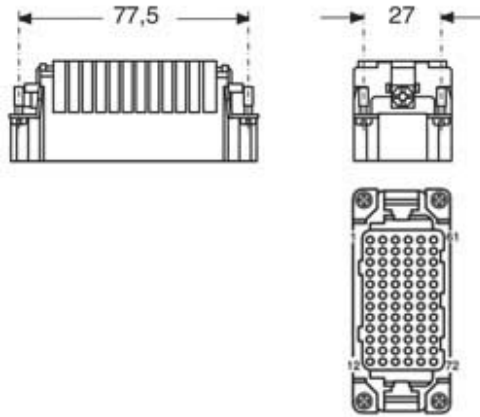

Derating curves

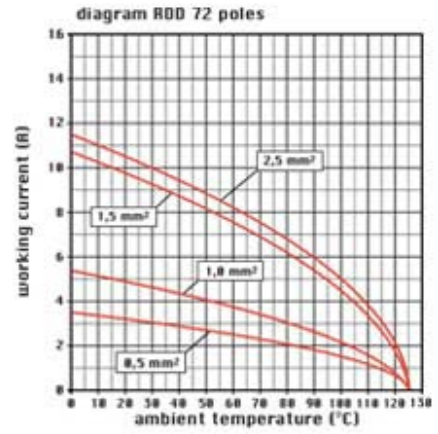

Notes

California Proposition 65 Information



WARNING

This product can expose you to nickel compounds, known to the State of California to cause cancer and/or reproductive toxicity. For more information go to www.P65Warnings.ca.gov.