

Part number

PK 6393 LL



Socket-outlet with circuit breaker and electrical interlock, PK series, 2 poles + PE, 9 h (red), 63 A, 380 ÷ 415 V

Product description

Product type	Socket-outlet with circuit breaker and electrical interlock
Series	PK..LL
N. of poles	2 poles + 
Clock position	9

Technical data

Current	63 A
Voltage	380 ÷ 415 V
IP degree of protection	IP55

Further technical details

Operating temperature range (min, max)	-25°C ... +40°C
IK rating (impact degree of protection)	IK10

Material properties

Colour	RAL 7035 grey, RAL 3000 red
---------------	-----------------------------

Approvals / Standards

Reference standard	EN 60309-1, -2 e -4
---------------------------	---------------------

General ordering information

EAN13 code	8015747159159
-------------------	---------------

Part number

PK 6393 LL



Catalogue drawings

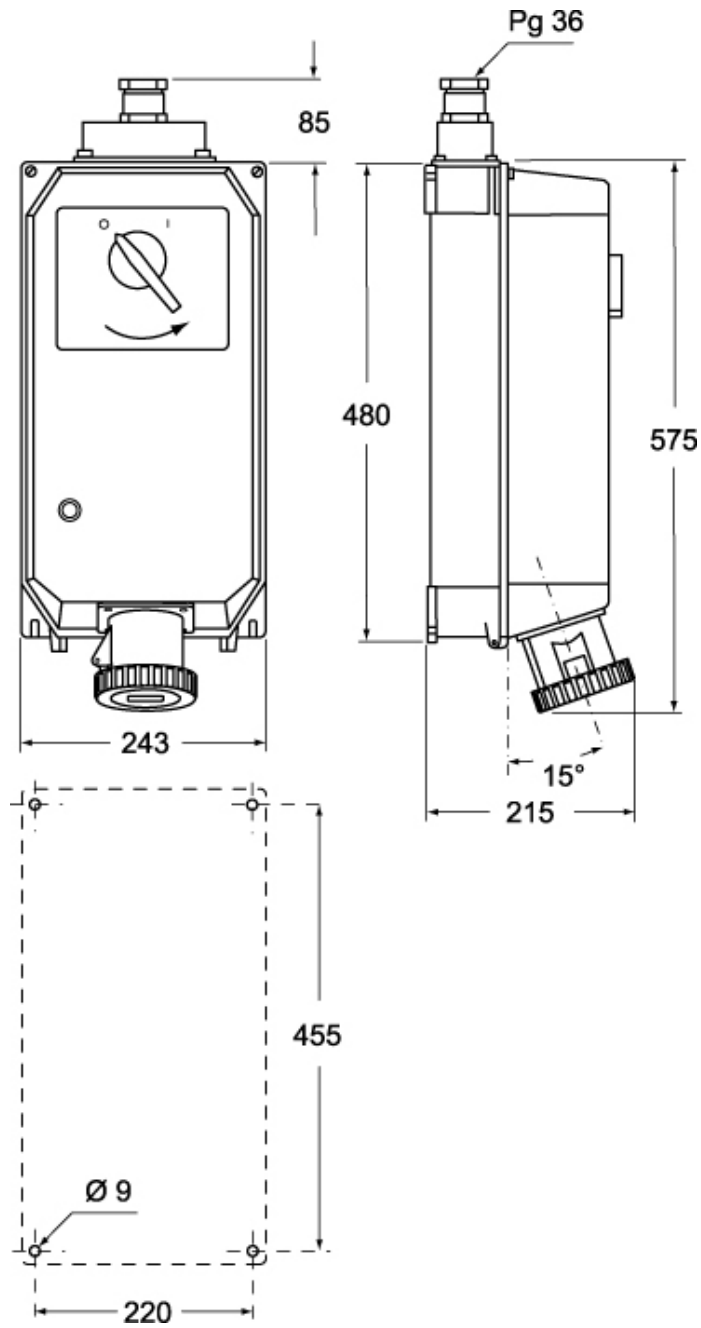

Notes