

Part number

PK 3244 EB



Interlocked switched socket-outlet, PK series, 3 poles + PE, 4 h (yellow), 32 A, 100 ÷ 130 V, without fuse-carrier

Product description		Material properties	
Product type	Interlocked switched socket-outlet	Colour	RAL 7035 grey, RAL 1021 yellow
Series	PK..EB		Compliant with exemption 6(c): copper alloy containing up to 4% lead by weight
N. of poles	3 poles +	RoHs conformity	50
Clock position	4	China RoHs - EFUP	50
Size	114x228 fixing plates FC xx41 TB	REACH SVHC substances	Yes Lead
Cable entry	Pg29	SCIP number	F6799547-ab84-42f2-938f-233ba663766d
Specification	Without fuse-carrier	Approvals / Standards	
Technical data		Reference standard	EN 60309-1, -2 e -4
Current	32 A	General ordering information	
Voltage	100 ÷ 130 V	EAN13 code	8015747081177
IP degree of protection	IP44	Packaging Information	
Further technical details		Sub-packaging length	290,00 mm
Weight	1.300,00 g	Sub-packaging height	125,00 mm
Operating temperature range (min, max)	-25°C ... +40°C	Sub-packaging width	155,00 mm
IK rating (impact degree of protection)	IK10	Sub-packaging weight	1,30 kg
		Sub-packaging volume	5,62 dm ³
		Sub-packaging description	Carton box
		Sub-packaging quantity	1 Pcs
		Sub-packaging EAN barcode	8015747081184

Part number

PK 3244 EB



Catalogue drawings

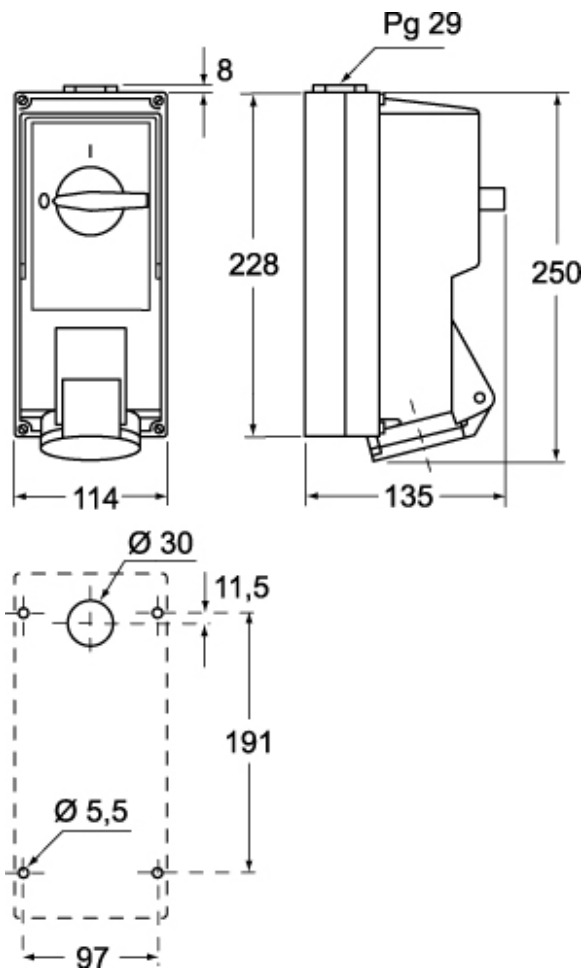

Notes