

Part number

PEW 63123 SI



Flush-mounting plug, PLUSO series, 2 poles + PE, 12 h (white), 63 A

Product description

Product type	Plug Flush-mounting
Series	PEW...SI, PLUSO
N. of poles	2 poles + 
Clock position	12

Technical data

Current	63 A
Voltage	ins. transformer
IP degree of protection	IP67

Further technical details

Operating temperature range (min, max)	-25°C ... +40°C
---	-----------------

Material properties

Colour	RAL 7035 grey, RAL 9010 white
---------------	-------------------------------

Approvals / Standards

Reference standard	EN 60309-1 and -2
---------------------------	-------------------

General ordering information

EAN13 code	8015747158244
-------------------	---------------

Part number

PEW 63123 SI



Catalogue drawings

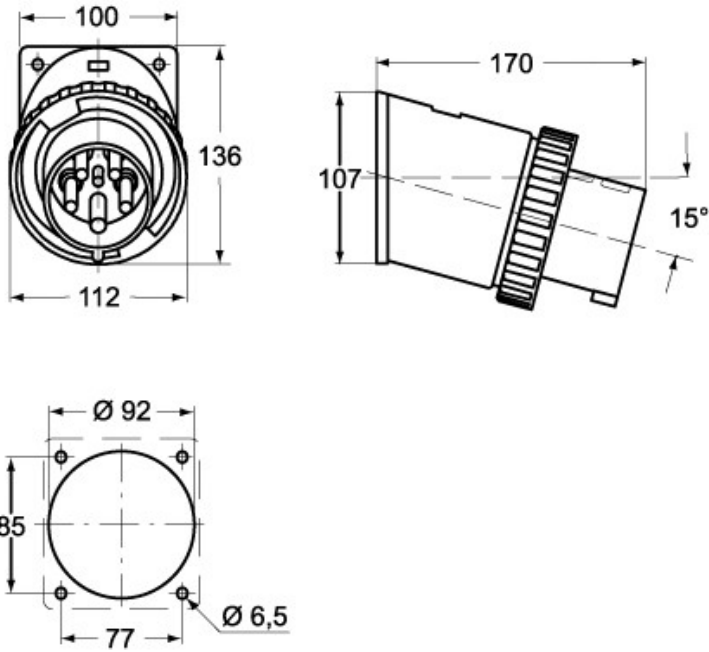

Notes