

Part number

PEW 3273 PP



Wall-mounting socket outlet, PLUSO series, 2 poles + PE, 7 h (black), 32 A, 480 ÷ 500 V

Product description

Product type	Socket Wall-mounting
Series	PEW...PP, PLUSO
N. of poles	2 poles + 
Clock position	7

Technical data

Current	32 A
Voltage	480 ÷ 500 V
IP degree of protection	IP67

Further technical details

Operating temperature range (min, max)	-25°C ... +40°C
---	-----------------

Material properties

Colour	RAL 7035 grey, RAL 9005 black
---------------	-------------------------------

Approvals / Standards

Reference standard	EN 60309-1 and -2
---------------------------	-------------------

General ordering information

EAN13 code	8015747158008
-------------------	---------------

Part number

PEW 3273 PP



Catalogue drawings

(16 / 32A) PEW ... PP

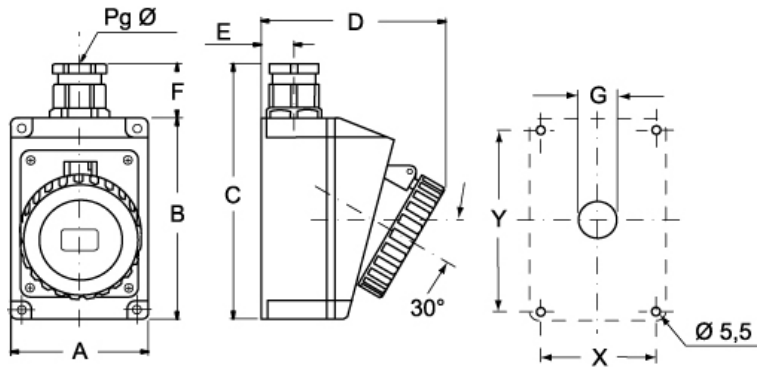

PEW ... PP	A	B	C	D	E	F	G	X	Y	Pg Ø
16A 2P+⊕	75	115	150	105	19	33	Ø22	65	105	16
3P+⊕	75	115	150	108	19	33	Ø22	65	105	16
3P+N+⊕	100	130	172	120	22	33	Ø22	85	115	21
32A 2P+⊕	100	130	172	120	22	42	Ø28	85	115	21
3P+⊕	100	130	172	120	22	42	Ø28	85	115	21
3P+N+⊕	100	130	172	120	22	42	Ø28	85	115	21

Notes