

Part number

MZOS 15 L25



Hood, EMC series, with 2 pegs, M25 side cable entry, size "49.16"

Product description

Product type	Hood
Series	EMC
Closing type	With 2 pegs
Size	Size 49.16
Cable entry	Side cable entry M25

Technical data

IP degree of protection IP65 / IP66 / IP69

Further technical details

Weight	88,00 g
Operating temperature range (min, max)	-40°C...+125°C

Material properties

RoHs conformity	Compliant
China RoHs - EFUP	E
REACH SVHC substances	No

Approvals / Standards

Certifications	DNV, BV
UL	ECBT2
cUL	ECBT8

General ordering information

EAN13 code	8015747154178
eCl@ss 8.1	27440202
ETIM 7.0	EC000437

Packaging Information

Sub-packaging length	120,00 mm
Sub-packaging height	105,00 mm
Sub-packaging width	160,00 mm
Sub-packaging weight	0,88 kg
Sub-packaging volume	2,02 dm ³
Sub-packaging description	Carton box
Sub-packaging quantity	10 Pcs
Sub-packaging EAN barcode	8015747176392

Part number

MZOS 15 L25



Catalogue drawings

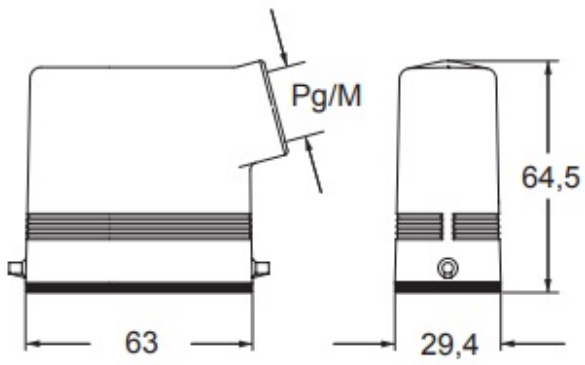

Notes