

Part number

MVAP 16LSP40



Surface mounting housing, V-TYPE series, with 1 lever, M40 cable entry, size "77.27", high construction, with SIMPLEX self-closing cover

Product description	
Product type	Surface mounting housing
Series	V-TYPE
Closing type	With 1 lever
Size	Size 77.27
Cable entry	With cable entry M40
Specification	High construction, with SIMPLEX self-closing cover
Technical data	
IP degree of protection	IP65
Further technical details	
Weight	449,00 g
Operating temperature range (min, max)	-40°C...+125°C

Material properties	
Other materials	Lever: Stainless steel Gasket: NBR
Colour	RAL 7040 grey
RoHs conformity	Compliant
China RoHs - EFUP	E
REACH SVHC substances	No
Approvals / Standards	
Certifications	DNV, BV
UL	ECBT2
cUL	ECBT8
General ordering information	
EAN13 code	8015747267441
eCl@ss 8.1	27440202
ETIM 7.0	EC000437
Packaging Information	
Packaging weight	4,50 kg
Packaging volume	18,29 dm ³
Packaging description	Carton box
Packaging quantity	10 Pcs
Packaging EAN code	8015747299497
Sub-packaging weight	2,25 kg
Sub-packaging description	Plastic packaging
Sub-packaging quantity	5 Pcs
Sub-packaging EAN barcode	8015747299503

Part number

MVAP 16LSP40



Catalogue drawings

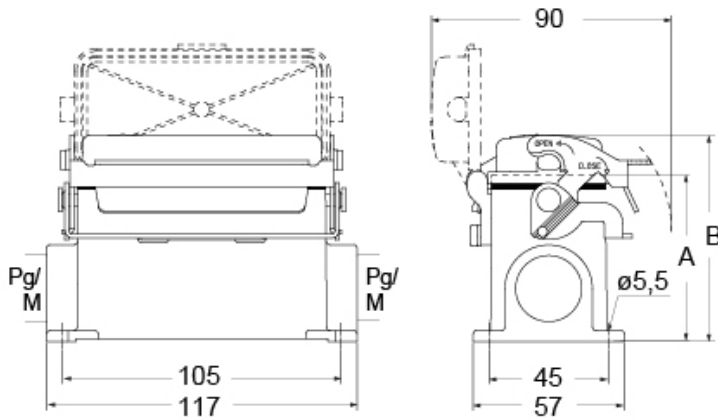

part No.	A	B
CVP / MVP 16 LSP	63	78
CVAP / MVAP 16 LSP	81	96

Notes