

Part number

MMAP 06 L240



Surface mounting housing, 830V series, with 1 lever, M40 x 2 cable entry, size "77.27", high construction

Product description

Product type	Surface mounting housing
Series	830V
Closing type	With 1 lever
Size	Size 77.27
Cable entry	With cable entry M40 x 2
Specification	High construction

Technical data

IP degree of protection IP65 / IP66 / IP69

Further technical details

Weight	390,00 g
Operating temperature range (min, max)	-40°C...+125°C

Material properties

Colour	RAL 7040 grey
RoHs conformity	Compliant
China RoHs - EFUP	E
REACH SVHC substances	No

Approvals / Standards

Certifications	DNV, BV
UL	ECBT2
cUL	ECBT8

General ordering information

EAN13 code 8015747057509

Packaging Information

Sub-packaging weight	1,95 kg
Sub-packaging description	Plastic packaging
Sub-packaging quantity	5 Pcs
Sub-packaging EAN barcode	8015747101233

Part number

MMAP 06 L240



Catalogue drawings

CMP L CMAP L - MMP L MMAP L

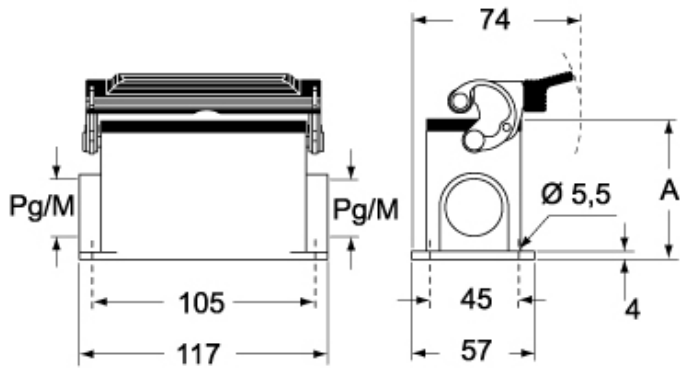

CMP LS CMAP LS - MMP LS MMAP LS

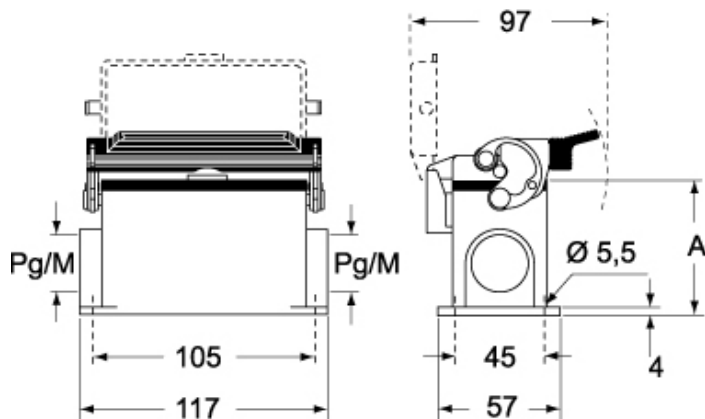

	A
CMP L / MMP L	63
CMAP L / MMAP L	77
CMP LS / MMP LS	63
CMAP LS / MMAP LS	77

Notes