

Part number

MHV 48 L50



Hood, C-TYPE series, with 2 pegs, M50 top cable entry, size "104.62"

Product description

Product type	Hood
Series	C-TYPE
Closing type	With 2 pegs
Size	Size 104.62
Cable entry	Top cable entry with adapter M50

Technical data

IP degree of protection IP65 / IP66 / IP69

Further technical details

Weight	743,00 g
Operating temperature range (min, max)	-40°C...+125°C

Material properties

Colour	RAL 7040 grey
RoHs conformity	Compliant with exemption 6(c): copper alloy containing up to 4% lead by weight
China RoHs - EFUP	50
REACH SVHC substances	Yes Lead
SCIP number	15deaf78-e939-4401-a0b0-e2228ca32a03

Approvals / Standards

Certifications	DNV, BV
UL	ECBT2
cUL	ECBT8

General ordering information

EAN13 code	8015747056441
eCl@ss 8.1	27440202
ETIM 7.0	EC000437

Packaging Information

Packaging length	190,00 mm
Packaging height	140,00 mm
Packaging width	290,00 mm
Packaging weight	3,07 kg
Packaging volume	7,71 dm ³
Packaging description	Carton box
Packaging quantity	4 Pcs
Packaging EAN code	8015747056458
Sub-packaging weight	0,77 kg
Sub-packaging description	Plastic packaging
Sub-packaging quantity	1 Pcs
Sub-packaging EAN barcode	8015747056465

Part number

MHV 48 L50



Catalogue drawings

CHO L - MHO L - MFO L

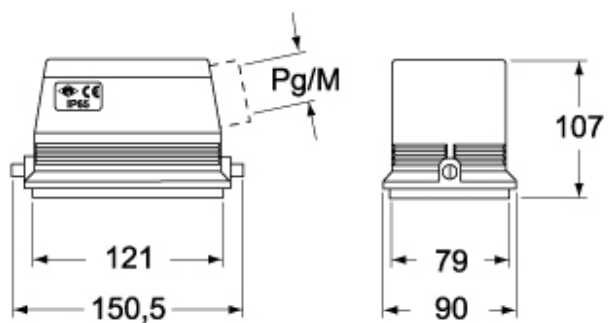

CHV L - MHV L - MFV L



Notes