

Part number

MHOS 16.32



Hood, EMC series, with 4 pegs, M32 side cable entry, size "77.27"

Product description

Product type	Hood
Series	EMC
Closing type	With 4 pegs
Size	Size 77.27
Cable entry	Side cable entry M32

Technical data

IP degree of protection IP65 / IP66 / IP69

Further technical details

Weight	175,00 g
Operating temperature range (min, max)	-40°C...+125°C

Material properties

RoHs conformity	Compliant
China RoHs - EFUP	E
REACH SVHC substances	No

Approvals / Standards

Certifications	DNV, BV
UL	ECBT2
cUL	ECBT8

General ordering information

EAN13 code	8015747152631
eCl@ss 8.1	27440202
ETIM 7.0	EC000437

Packaging Information

Packaging length	270,00 mm
Packaging height	130,00 mm
Packaging width	135,00 mm
Packaging weight	2,00 kg
Packaging volume	4,74 dm ³
Packaging description	Carton box
Packaging quantity	10 Pcs
Packaging EAN code	8015747211659
Sub-packaging weight	0,20 kg
Sub-packaging description	Plastic packaging
Sub-packaging quantity	1 Pcs
Sub-packaging EAN barcode	8015747211666

Part number

MHOS 16.32



Catalogue drawings

CHOS (CAOS) - MHOS (MAOS)



CHVS (CAVS) - MHVS (MAVS)



CHCS G



Catalogue drawings

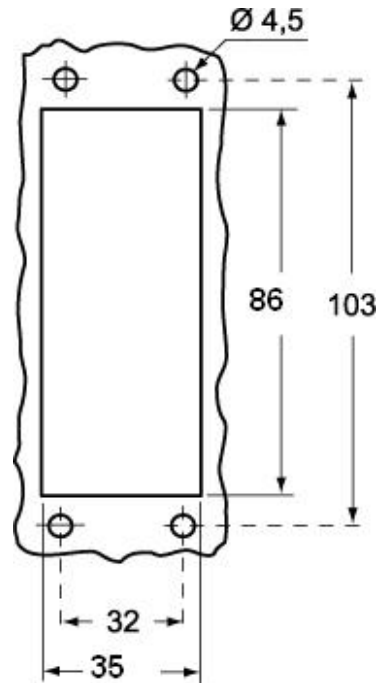

Notes