

Part number

MGV 24.232 B



Hood, IP68 series, with 2 bayonets, M32 x 2 top cable entry, size "104.27"

Product description		Material properties	
Product type	Hood	Main material	Aluminium die-cast
Series	IP68	Other materials	Bayonet: Stainless steel
Closing type	With 2 bayonets	Colour	RAL 9005 black
Size	Size 104.27	RoHs conformity	Compliant
Cable entry	Top cable entry M32 x 2	China RoHs - EFUP	E
Technical data		REACH SVHC substances	No
IP degree of protection	IP66 / IP68 / IP69	Approvals / Standards	
Further technical details		Certifications	DNV, BV
Weight	548,00 g	UL	ECBT2
Operating temperature range (min, max)	-40°C...+125°C	cUL	ECBT8
		General ordering information	
		EAN13 code	8015747124133
		eCl@ss 8.1	27440202
		ETIM 7.0	EC000437
		Packaging Information	
		Packaging length	205,00 mm
		Packaging height	135,00 mm
		Packaging width	135,00 mm
		Packaging weight	1,20 kg
		Packaging volume	3,74 dm ³
		Packaging description	Carton box
		Packaging quantity	2 Pcs
		Packaging EAN code	8015747124515
		Sub-packaging weight	0,60 kg
		Sub-packaging description	Plastic packaging
		Sub-packaging quantity	1 Pcs
		Sub-packaging EAN barcode	8015747124522

Part number

MGV 24.232 B



Catalogue drawings

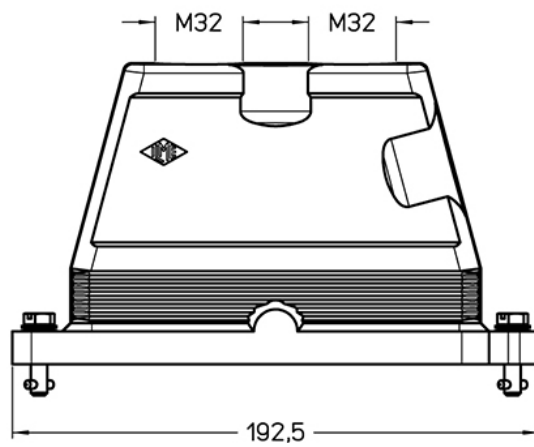
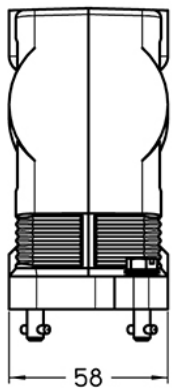
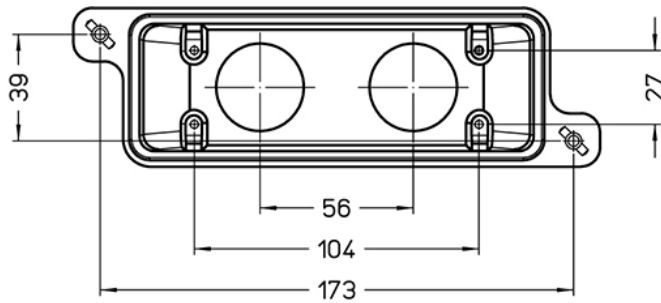

Notes