

Part number

# MFVE 06 L40M



Hood, E-Xtreme® V-TYPE series, with 2 pegs, M40 top cable entry without adapter, size "44.27", high construction

#### Product description

<b>Product type</b>	Hood
<b>Series</b>	E-Xtreme® V-TYPE
<b>Closing type</b>	With 2 pegs
<b>Size</b>	Size 44.27
<b>Cable entry</b>	Top cable entry M40
<b>Specification</b>	High construction

#### Technical data

**IP degree of protection** IP66 / IP67 / IP69

#### Further technical details

<b>Weight</b>	160,00 g
<b>Operating temperature range (min, max)</b>	-40°C...+125°C

#### Material properties

<b>Colour</b>	RAL 7016 grey
<b>RoHs conformity</b>	Compliant
<b>China RoHs - EFUP</b>	E
<b>REACH SVHC substances</b>	No

#### Approvals / Standards

<b>Certifications</b>	DNV, BV
<b>UL</b>	ECBT2
<b>cUL</b>	ECBT8

#### General ordering information

<b>EAN13 code</b>	8015747239899
<b>eCl@ss 8.1</b>	27440202
<b>ETIM 7.0</b>	EC000437

#### Packaging Information

<b>Packaging length</b>	175,00 mm
<b>Packaging height</b>	195,00 mm
<b>Packaging width</b>	260,00 mm
<b>Packaging weight</b>	1,85 kg
<b>Packaging volume</b>	8,87 dm <sup>3</sup>
<b>Packaging description</b>	Carton box
<b>Packaging quantity</b>	10 Pcs
<b>Packaging EAN code</b>	8015747239905
<b>Sub-packaging weight</b>	0,93 kg
<b>Sub-packaging description</b>	Plastic packaging
<b>Sub-packaging quantity</b>	5 Pcs
<b>Sub-packaging EAN barcode</b>	8015747239912

Part number

# MFVE 06 L40M



Catalogue drawings

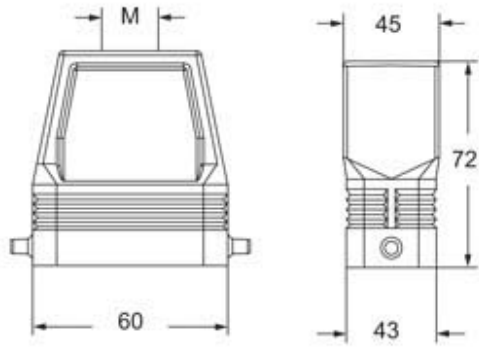

---

Notes