

Part number

MFO 48 L32



Hood, C-TYPE series, with 2 pegs, M32 side cable entry without adapter, size "104.62"

Product description

Product type	Hood
Series	C-TYPE
Closing type	With 2 pegs
Size	Size 104.62
Cable entry	Side cable entry M32

Technical data

IP degree of protection	IP65 / IP66 / IP69
--------------------------------	--------------------

Further technical details

Weight	600,00 g
Operating temperature range (min, max)	-40°C...+125°C

Material properties

Colour	RAL 7040 grey
RoHs conformity	Compliant
China RoHs - EFUP	E
REACH SVHC substances	No

Approvals / Standards

Certifications	DNV, BV
UL	ECBT2
cUL	ECBT8

General ordering information

EAN13 code	8015747114684
eCl@ss 8.1	27440202
ETIM 7.0	EC000437

Packaging Information

Packaging length	290,00 mm
Packaging height	140,00 mm
Packaging width	215,00 mm
Packaging weight	2,50 kg
Packaging volume	8,73 dm ³
Packaging description	Carton box
Packaging quantity	4 Pcs
Packaging EAN code	8015747114691
Sub-packaging weight	0,63 kg
Sub-packaging description	Plastic packaging
Sub-packaging quantity	1 Pcs
Sub-packaging EAN barcode	8015747114707

Part number

MFO 48 L32



Catalogue drawings

CHO L - MHO L - MFO L

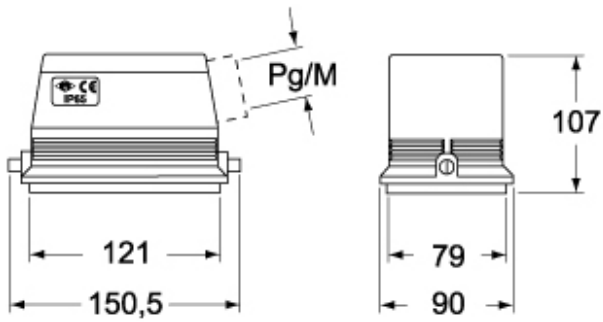

CHV L - MHV L - MFV L

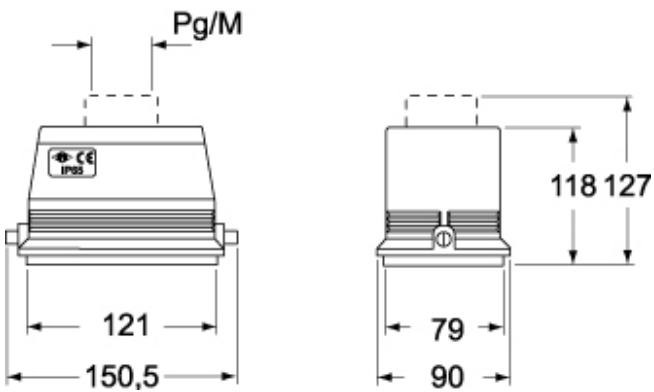

Catalogue drawings

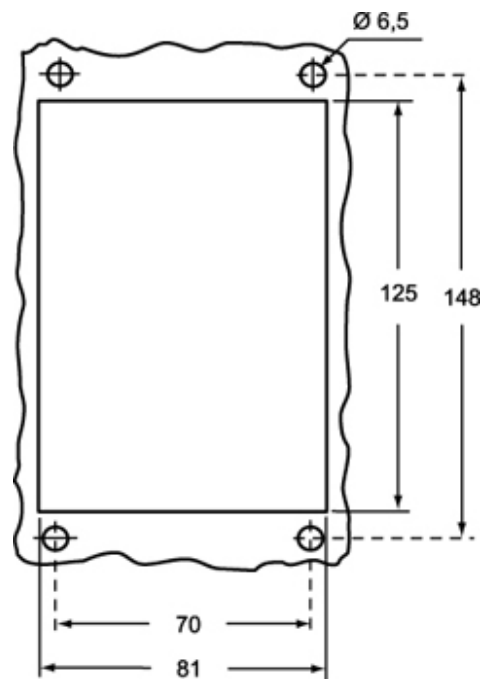

Notes