

Part number

MFO 06 LG40



Hood, C-TYPE series, with 1 lever, M40 side cable entry without adapter, size "44.27", high construction

Product description		Material properties	
Product type	Hood	Other materials	Lever: Stainless steel, polyamide (PA) Gasket: NBR
Series	C-TYPE	Colour	RAL 7040 grey
Closing type	With 1 lever	RoHs conformity	Compliant
Size	Size 44.27	China RoHs - EFUP	E
Cable entry	Side cable entry M40	REACH SVHC substances	No
Specification	High construction	Approvals / Standards	
Technical data		Certifications	DNV, BV
IP degree of protection	IP65 / IP66 / IP69	UL	ECBT2
Further technical details		cUL	ECBT8
Weight	207,00 g	General ordering information	
Operating temperature range (min, max)	-40°C...+125°C	EAN13 code	8015747234924
		eCl@ss 8.1	27440202
		ETIM 7.0	EC000437
		Packaging Information	
		Packaging length	160,00 mm
		Packaging height	130,00 mm
		Packaging width	270,00 mm
		Packaging weight	2,08 kg
		Packaging volume	5,62 dm ³
		Packaging description	Carton box
		Packaging quantity	10 Pcs
		Packaging EAN code	8015747235068
		Sub-packaging weight	1,04 kg
		Sub-packaging description	Plastic packaging
		Sub-packaging quantity	5 Pcs
		Sub-packaging EAN barcode	8015747235075

Part number

MFO 06 LG40



Catalogue drawings

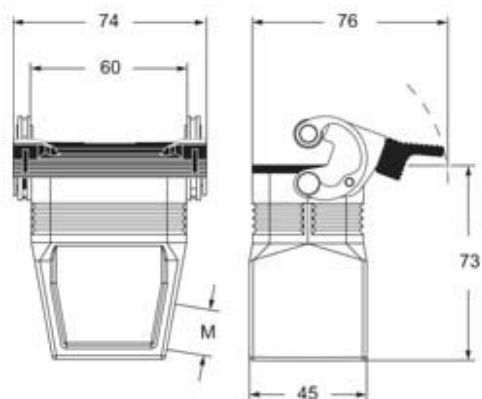

Notes